

В ПОМОЩЬ ЛОГОПЕДУ

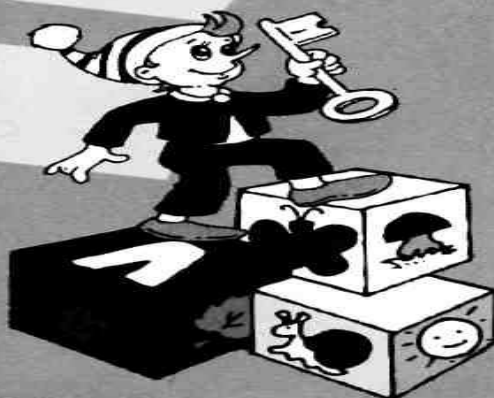

ТЕМАТИЧЕСКИЕ КАРТОЧКИ

для работы
по развитию
и коррекции
речи детей



?!
АБВГДЕЖ



ОТ АВТОРА

Тематические иллюстрации пособия предназначены для работы по развитию и коррекции речи детей дошкольного и младшего школьного возраста. Разрезные карточки-картинки можно использовать как приложение к книге «1500 загадок от логопеда в подарок» (автор-составитель Т. В. Пятница), а также к другим сборникам загадок и стихов для детей вышеуказанного возраста.

Объединение текста загадки с отгадкой-картинкой вызывает у детей интерес, стимулирует отгадывание, облегчает этот процесс; уточняя отгадку, подчеркивает детали, признаки предмета или явления; помогает создать образ, развивает воображение.





· И · Г · Р · У · Ш · К · И ·

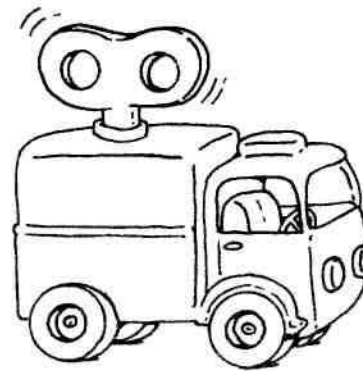
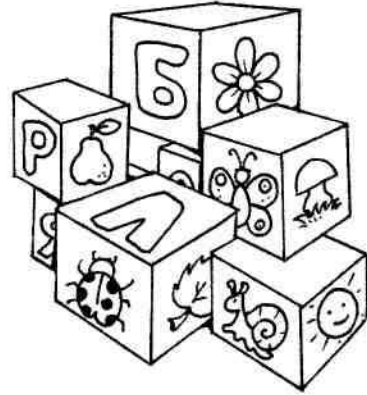
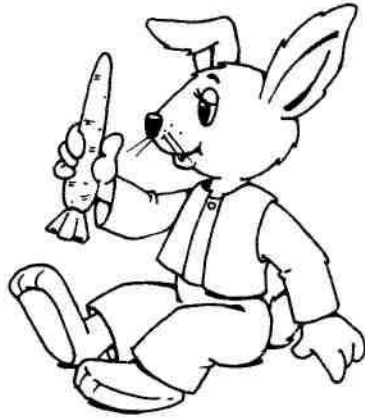



И · Г · Р · У · Ш · К · И ·

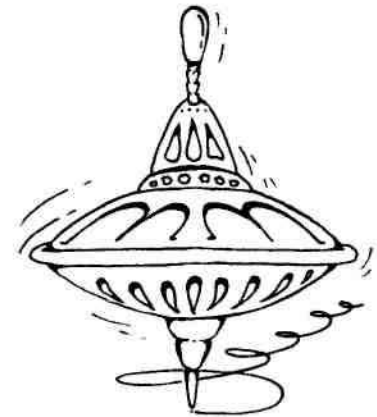
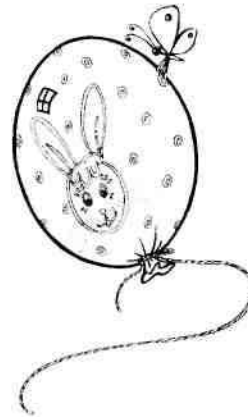
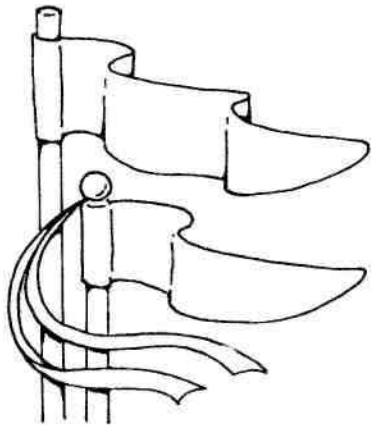
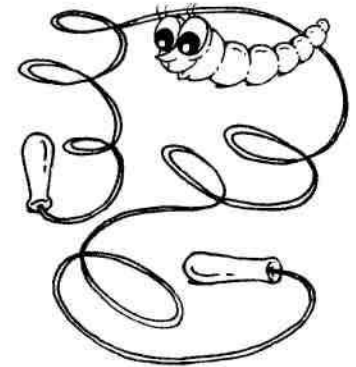
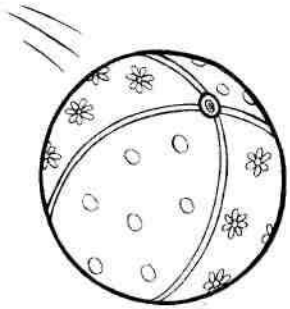



· О · Д · Е · Ж · Д · А ·

· О · Б · У · В · Ъ ·

· 7 ·

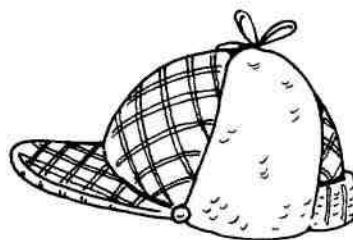
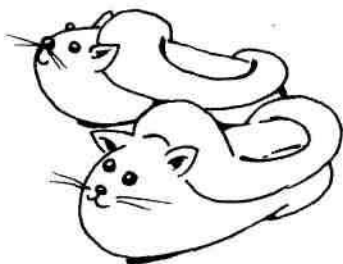

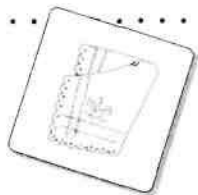

· Г · И · Г · И · Е · Н · А ·

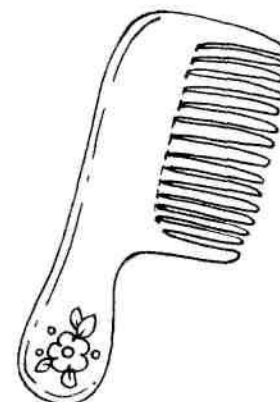
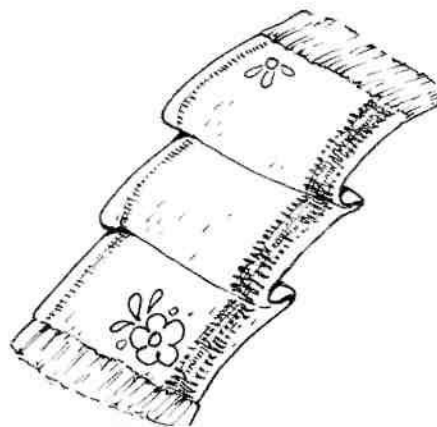
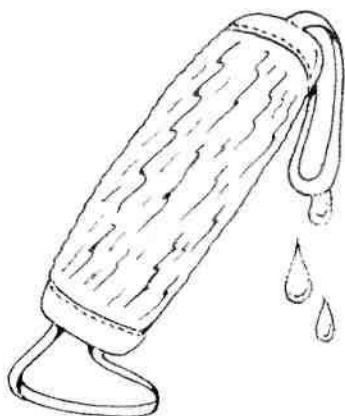
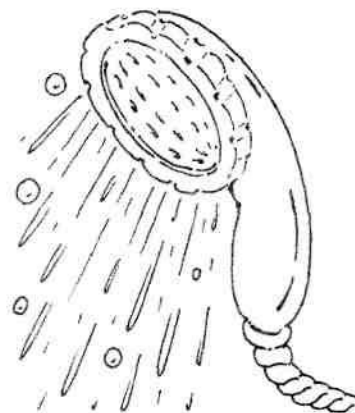

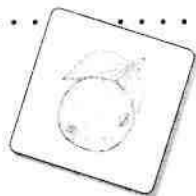

·О·В·О·Щ·И·

·Ф·Р·У·К·Т·Ы·

· 11 ·

·Я·Г·О·Д·Ы·

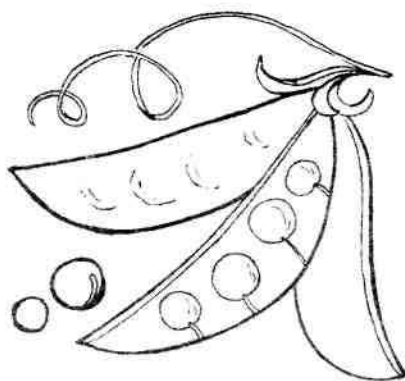
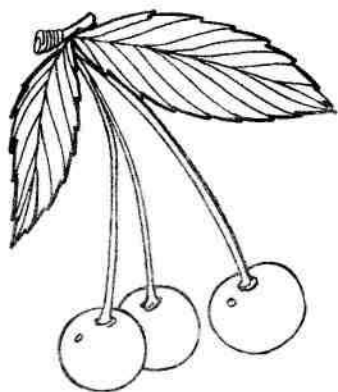
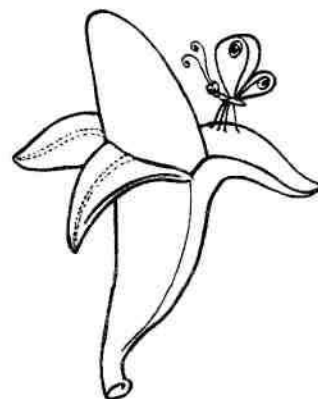

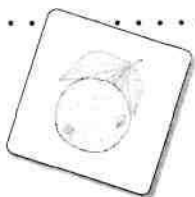

·О·В·О·Щ·И·

·Ф·Р·У·К·Т·Ы·

· 13 ·

·Я·Г·О·Д·Ы·

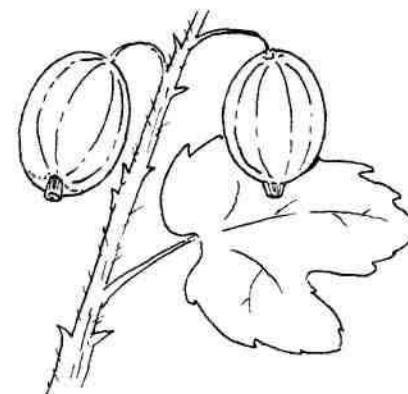
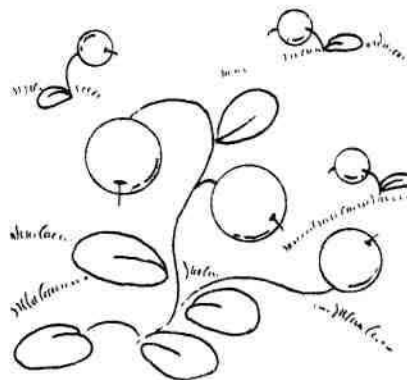
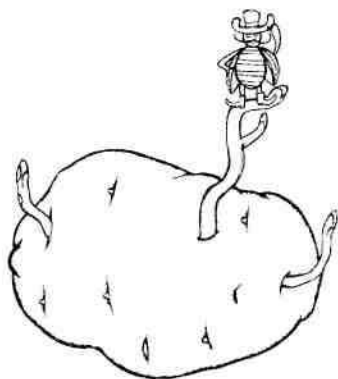
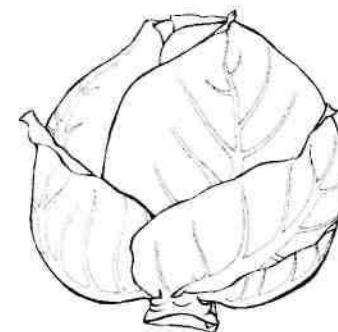
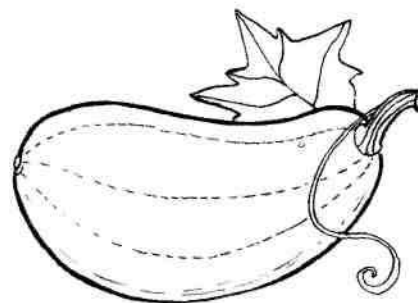
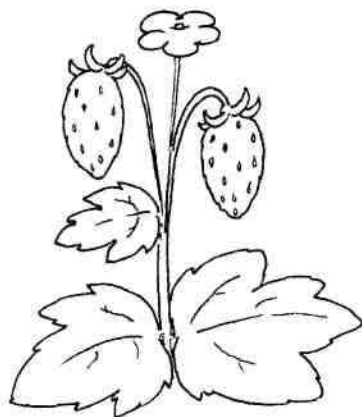
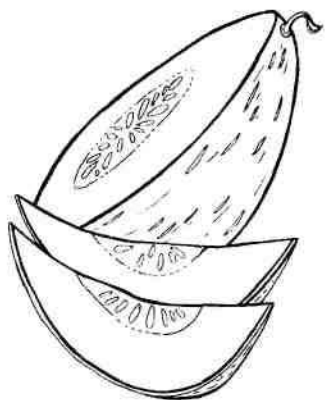

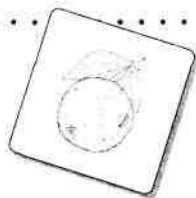

· О · В · О · Щ · И ·

· Ф · Р · У · К · Т · Ы ·

· 15 ·

· Я · Г · О · Д · Ы ·

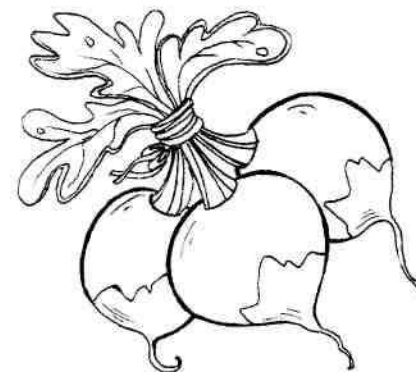
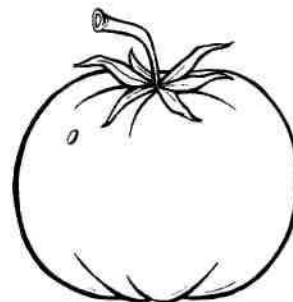
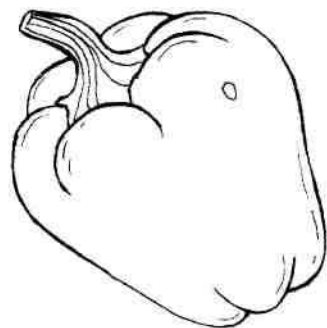
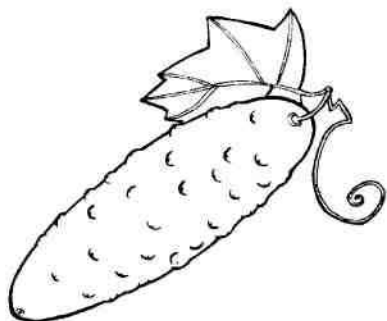
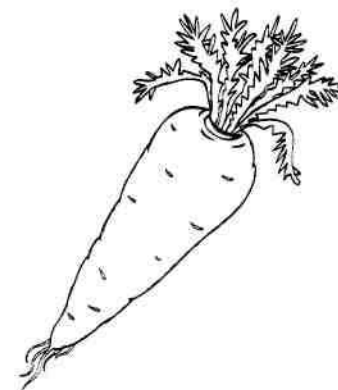
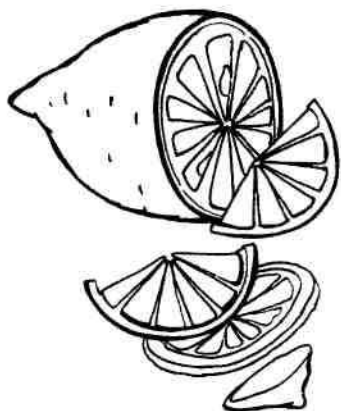

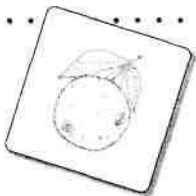

·О·В·О·Щ·И·

·Ф·Р·У·К·Т·Ы·

· 17 ·

·Я·Г·О·Д·Ы·

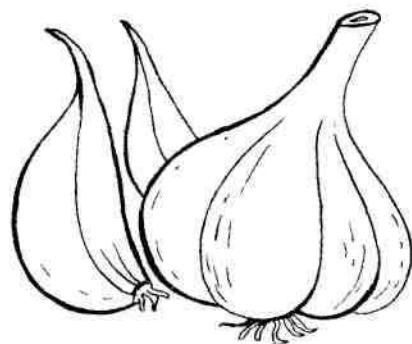
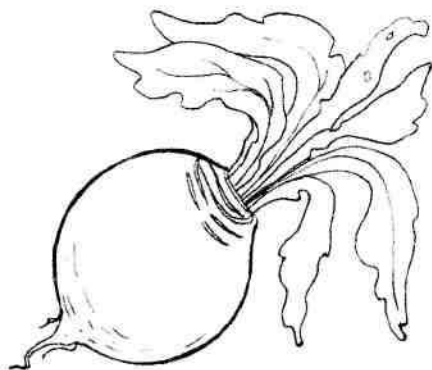
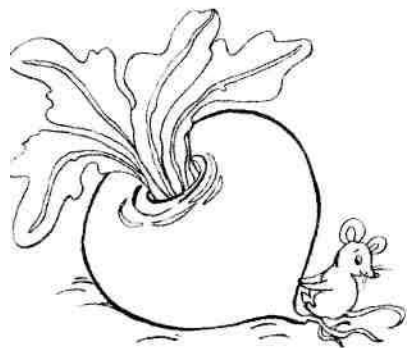



· П · Р · О · Д · У · К · Т · Ы ·

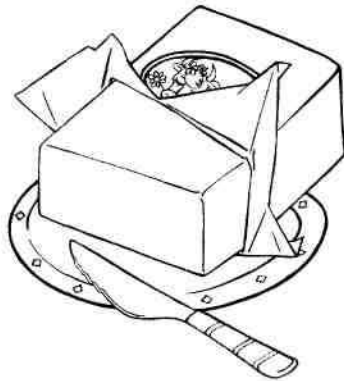
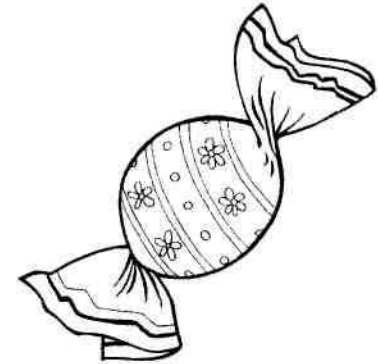
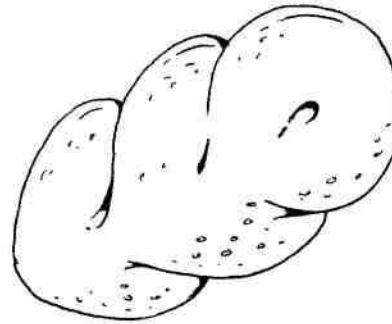
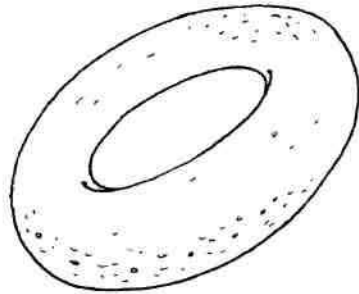
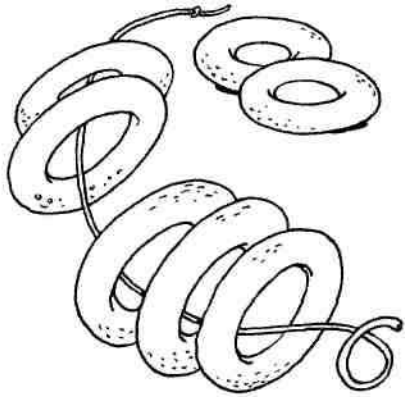



· П · Р · О · Д · У · К · Т · Ы ·

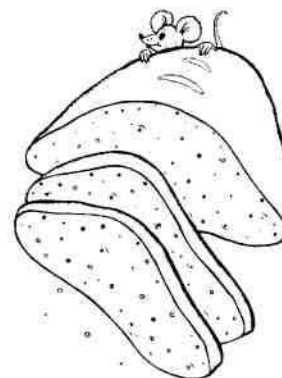
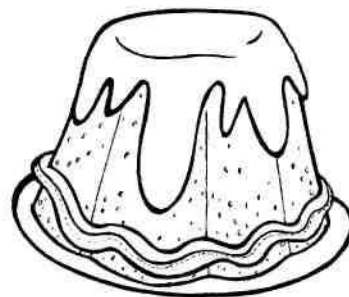
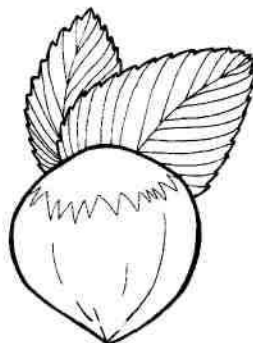



· Д · О · М ·

· М · Е · Б · Е · Л · Ъ ·

· 23 ·

· П · Р · Е · Д · М · Е · Т · Ы ·

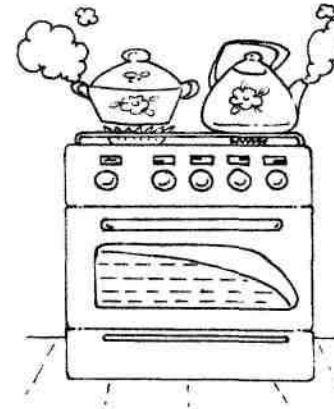
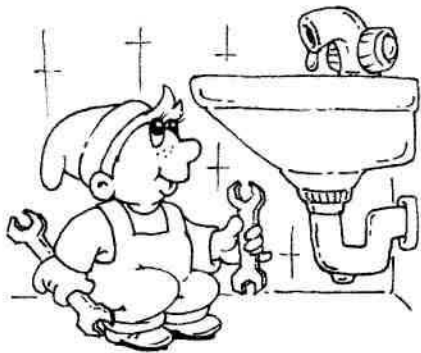
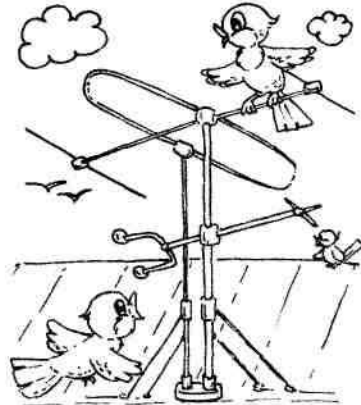



· Д · О · М ·

· М · Е · Б · Е · Л · Ъ ·

· 25 ·

· П · Р · Е · Д · М · Е · Т · Ы ·

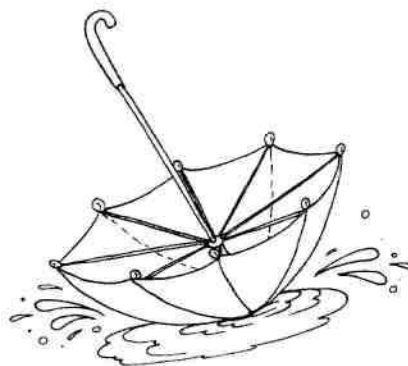
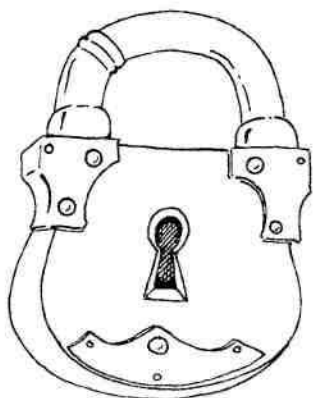
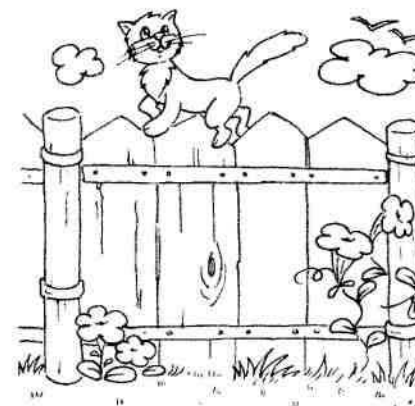



·Д·О·М·

·М·Е·Б·Е·Л·Ь·

·27·

·П·Р·Е·Д·М·Е·Т·Ы·

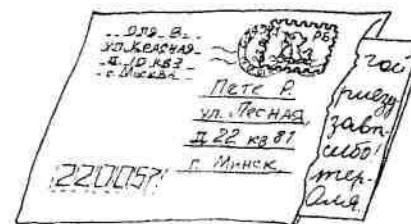
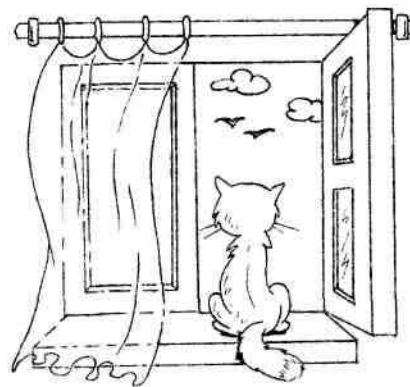
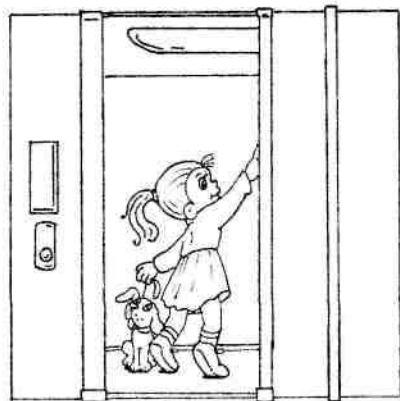
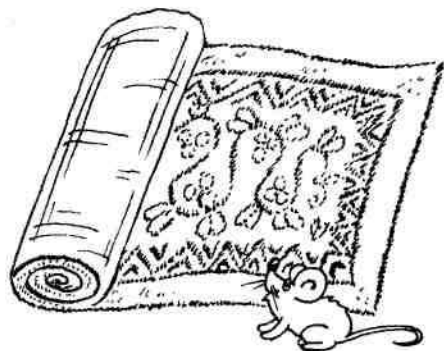



·Д·О·М·

·М·Е·Б·Е·Л·Ь·

·29·

·П·Р·Е·Д·М·Е·Т·Ы·

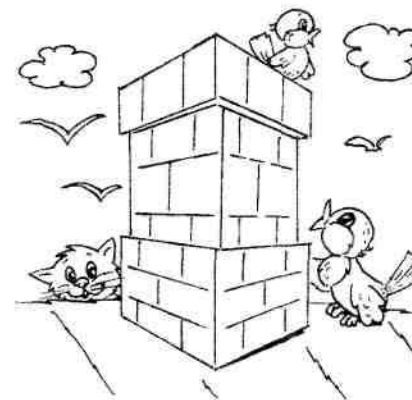
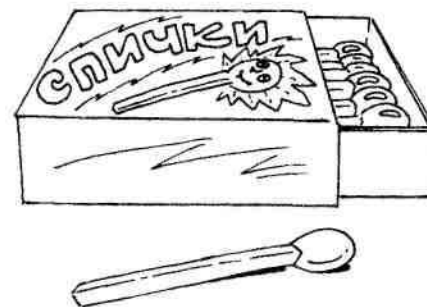
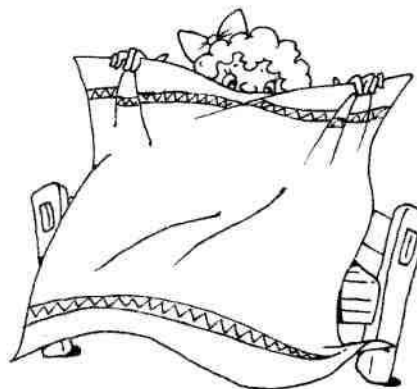
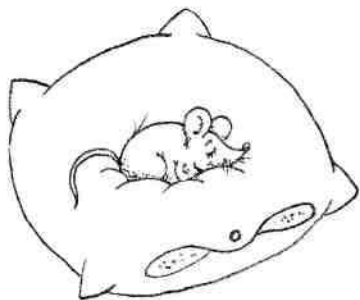

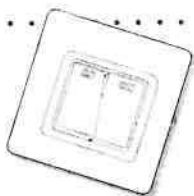

· Б · Ы · Т · О · В · Ы · Е · П · Р · И · Б · О · Р · Ы ·

· И · Н · С · Т · Р · У · М · Е · Н · Т · Ы ·

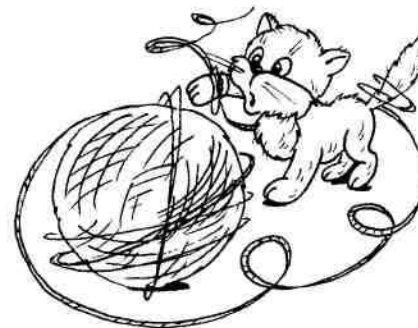
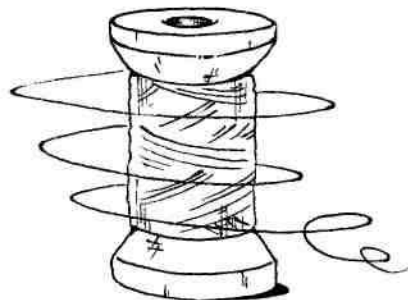
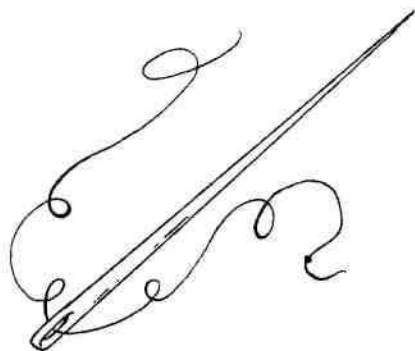
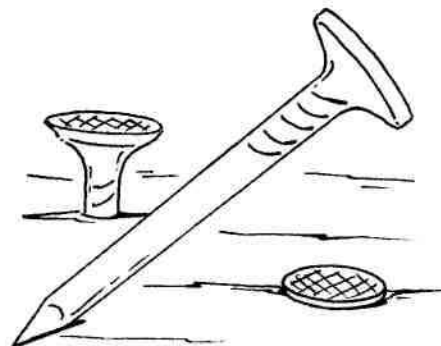
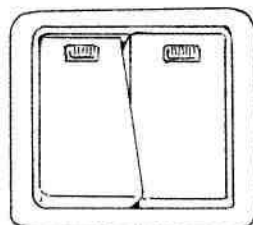
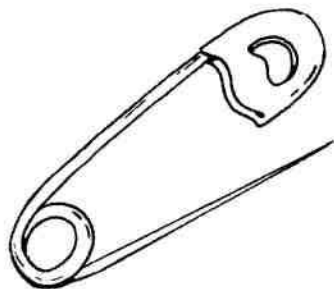

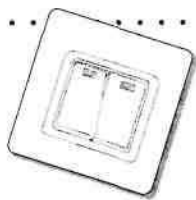

· Б · Ы · Т · О · В · Ы · Е · П · Р · И · Б · О · Р · Ы ·

· И · Н · С · Т · Р · У · М · Е · Н · Т · Ы ·

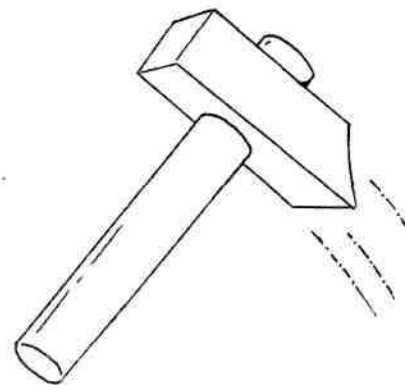
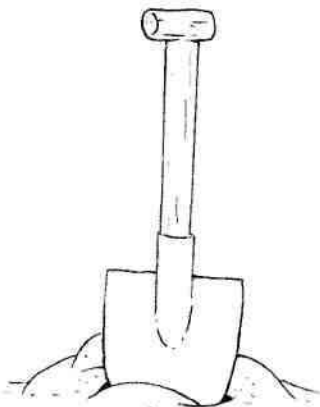
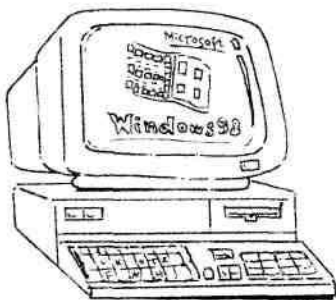
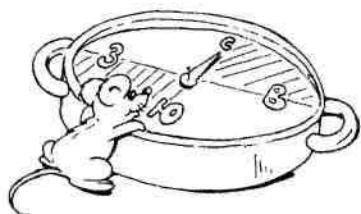

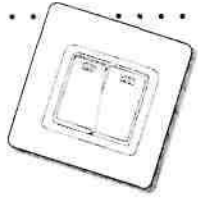

· Б · Ы · Т · О · В · Ы · Е · П · Р · И · Б · О · Р · Ы ·

· 35 ·

· И · Н · С · Т · Р · У · М · Е · Н · Т · Ы ·

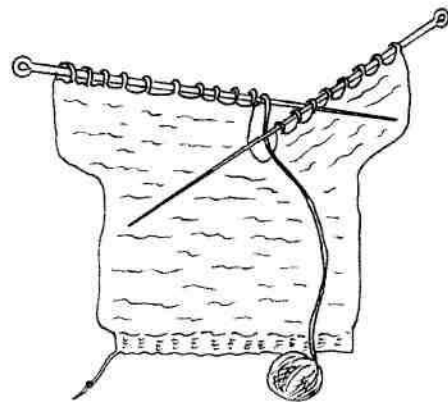
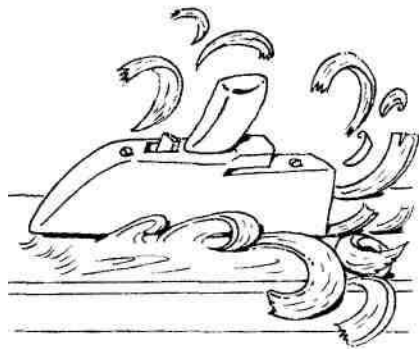
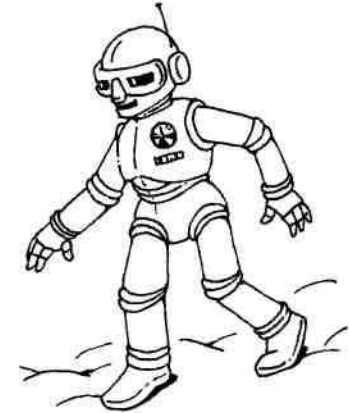
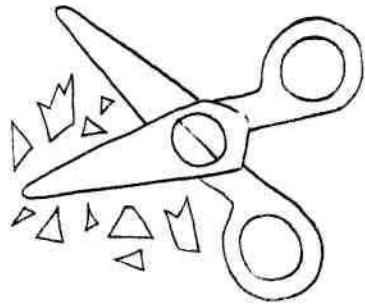

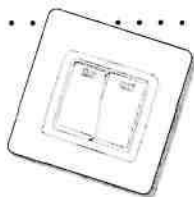

· Б · Ы · Т · О · В · Ы · Е · П · Р · И · Б · О · Р · Ы ·

· И · Н · С · Т · Р · У · М · Е · Н · Т · Ы ·

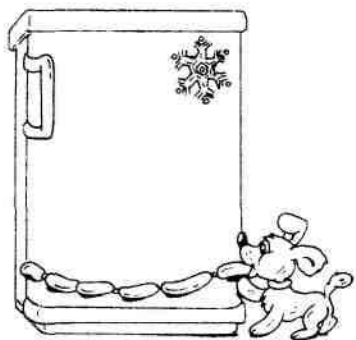
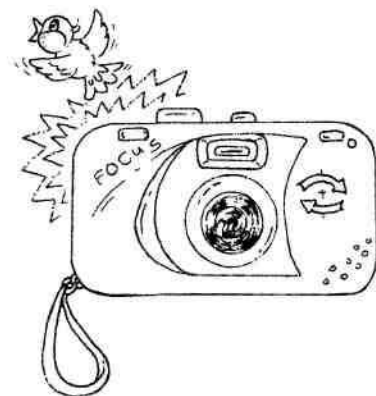
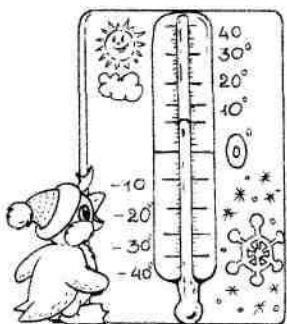



· П · О · С · У · Д · А ·

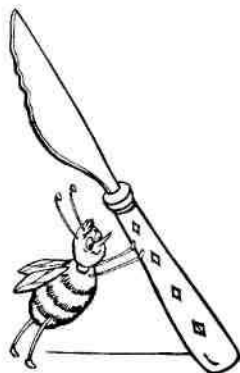
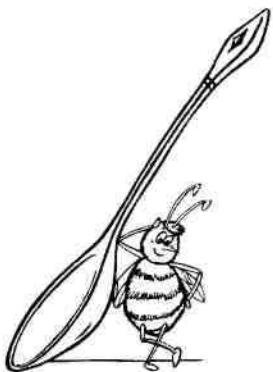
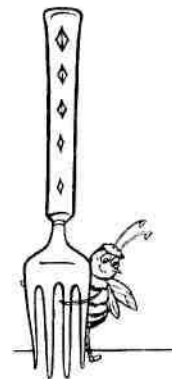
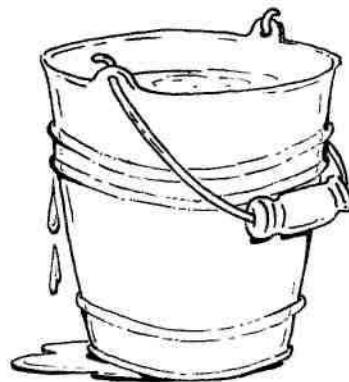



· П · О · С · У · Д · А ·

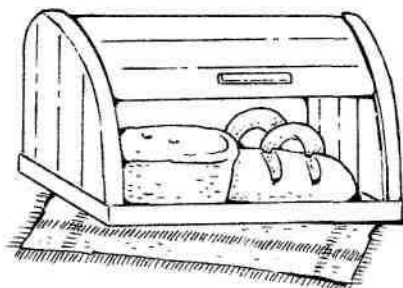
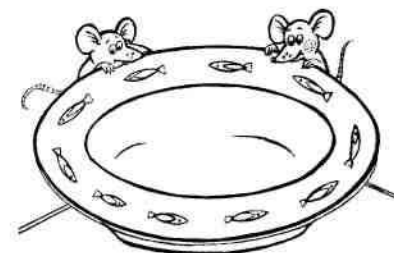
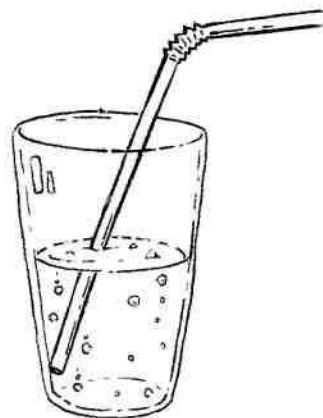
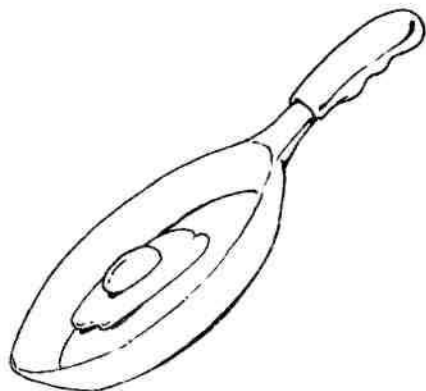
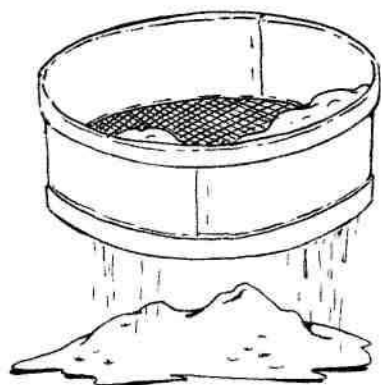

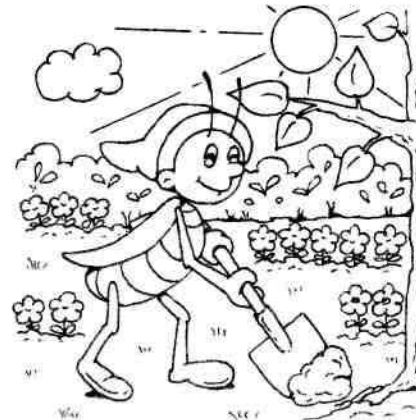

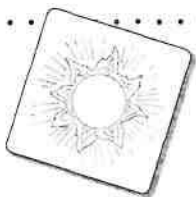

· В · Р · Е · М · Е · Н · А · · Г · О · Д · А ·

· 45 ·

· Я · В · Л · Е · Н · И · Я · · П · Р · И · Р · О · Д · Ы ·

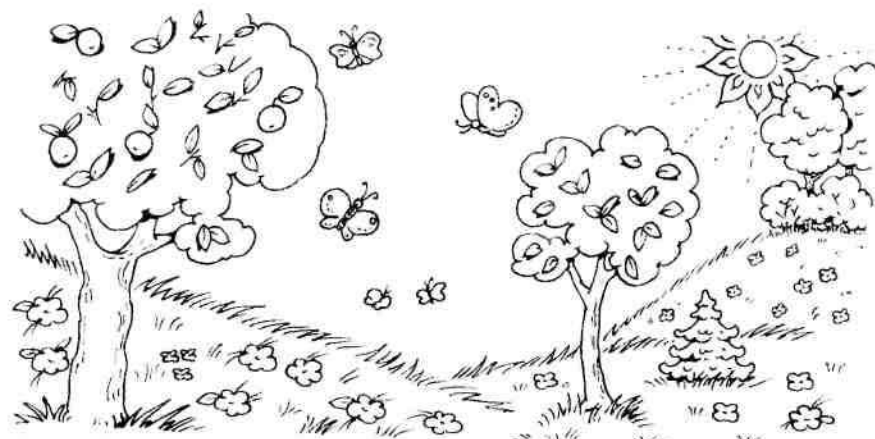
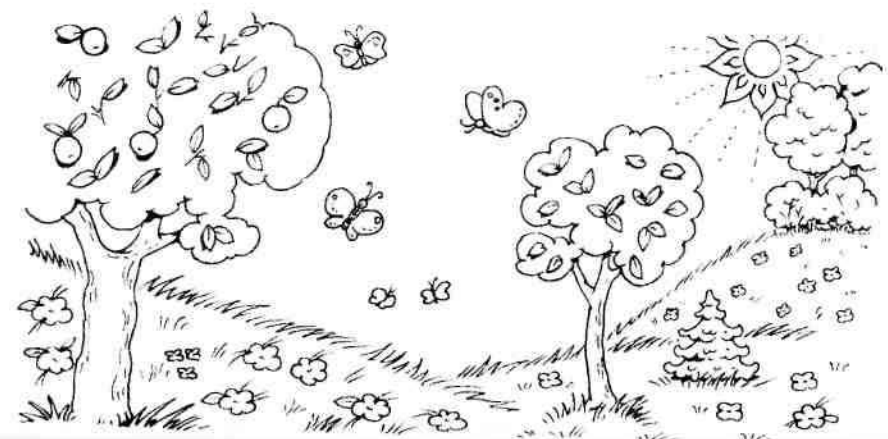
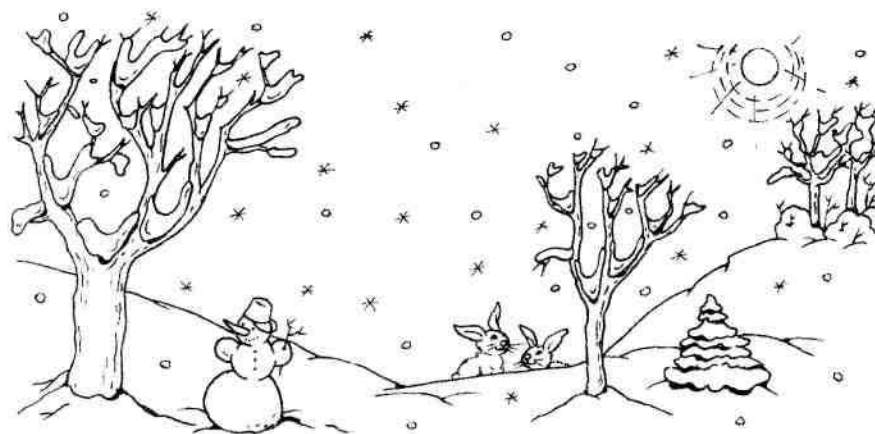
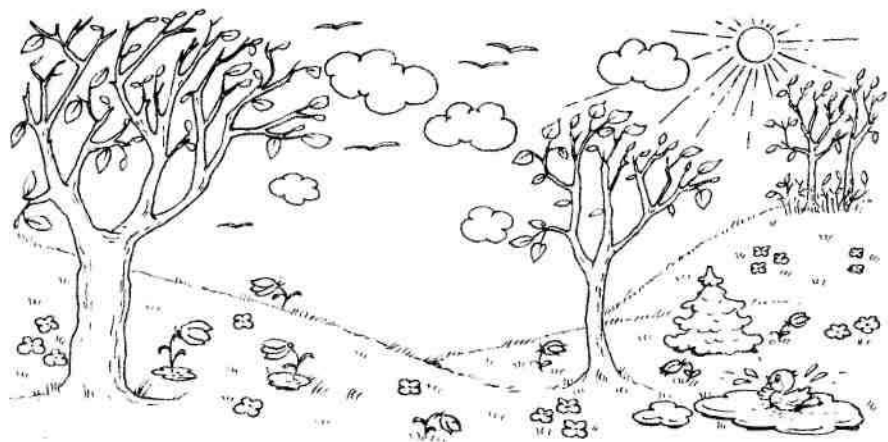



· В · Р · Е · М · Е · Н · А · · Г · О · Д · А ·

· 47 ·

· Я · В · Л · Е · Н · И · Я · · П · Р · И · Р · О · Д · Ы ·

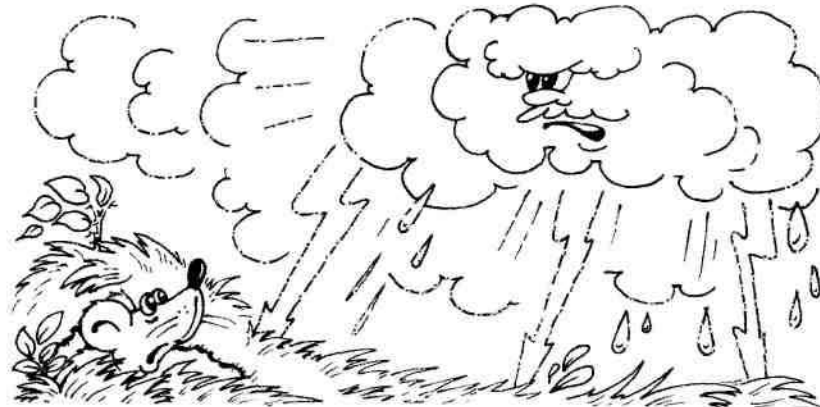



· В · Р · Е · М · Е · Н · А · · Г · О · Д · А ·

· Я · В · Л · Е · Н · И · Я · · П · Р · И · Р · О · Д · Ы ·

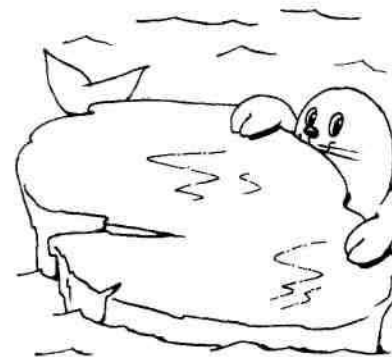
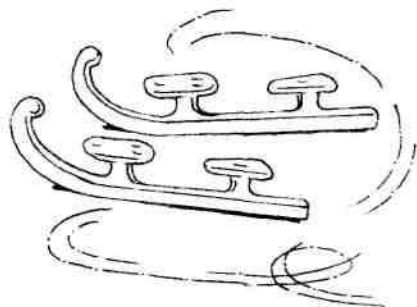
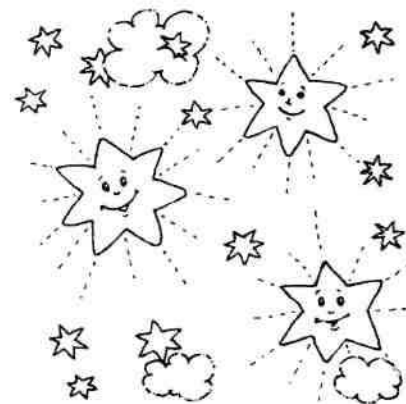



· В · Р · Е · М · Е · Н · А · · Г · О · Д · А ·

· Я · В · Л · Е · Н · И · Я · · П · Р · И · Р · О · Д · Ы ·

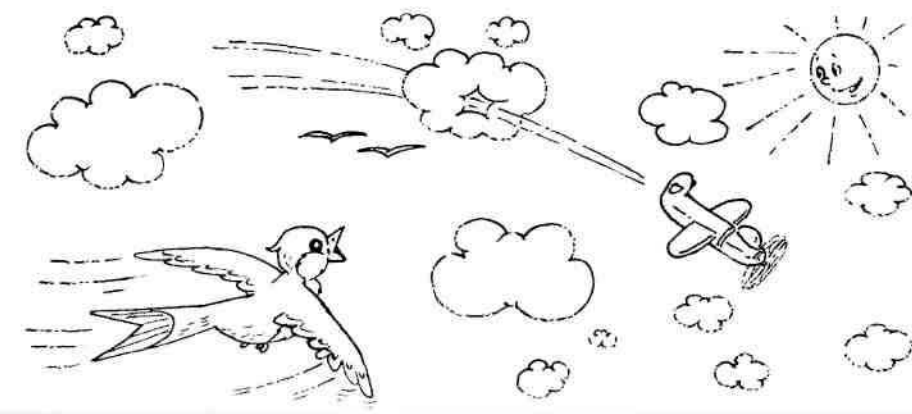
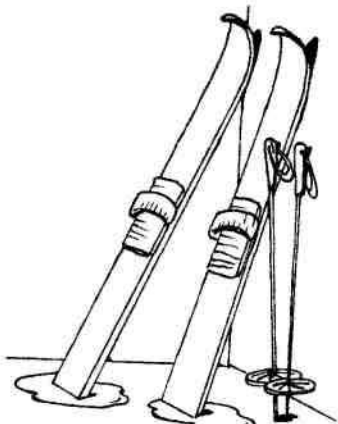



· В · Р · Е · М · Е · Н · А · · Г · О · Д · А ·

· 53 ·

· Я · В · Л · Е · Н · И · Я · · П · Р · И · Р · О · Д · Ы ·

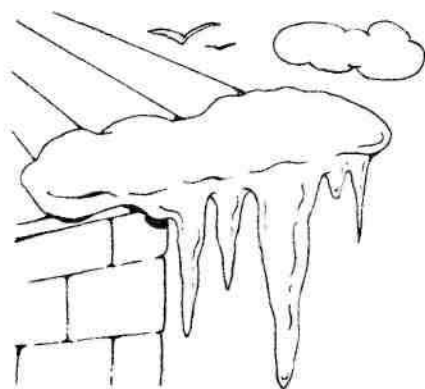
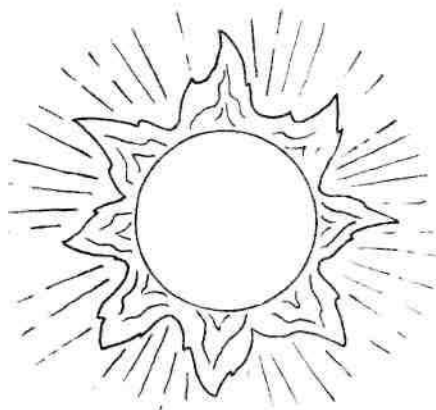
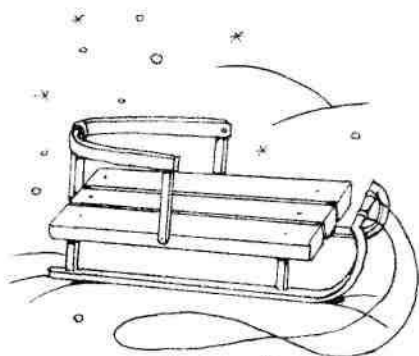



·Т·Р·А·Н·С·П·О·Р·Т·

·Т·Е·Х·Н·И·К·А·

·Д·О·Р·О·Г·А·

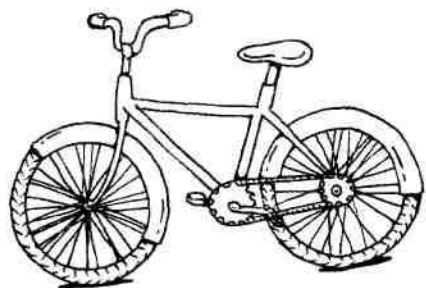
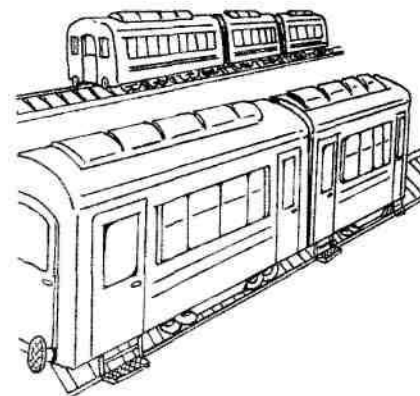
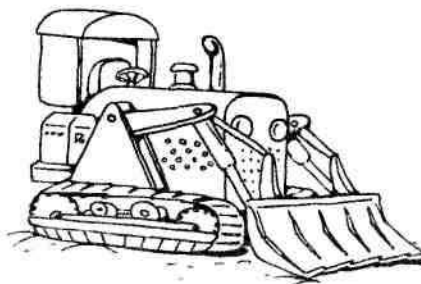
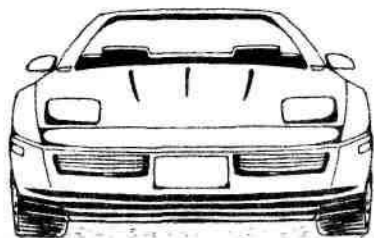
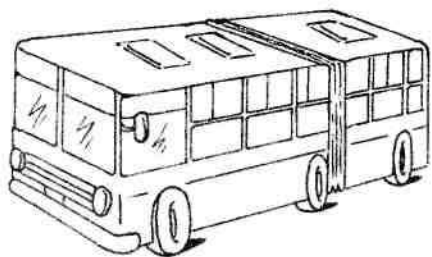



·Т·Р·А·Н·С·П·О·Р·Т·

·Д·О·Р·О·Г·А·

·57·

·Т·Е·Х·Н·И·К·А·

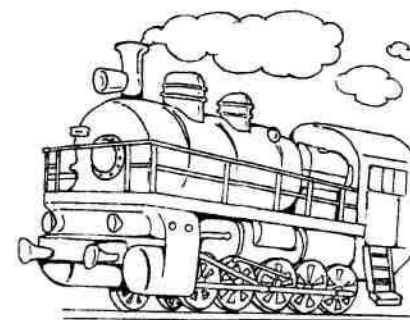
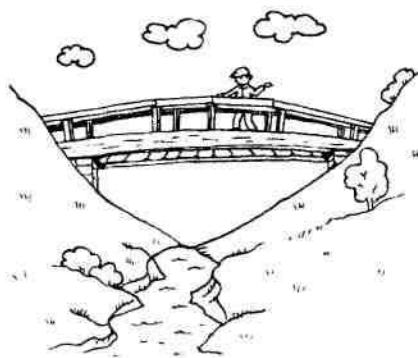
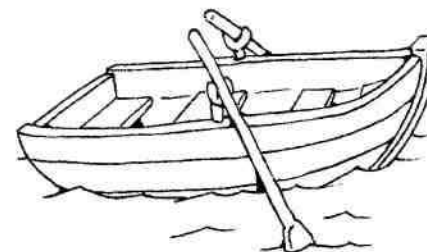
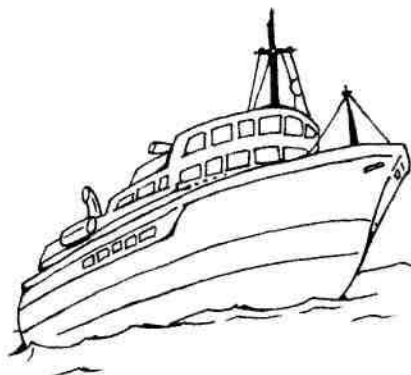
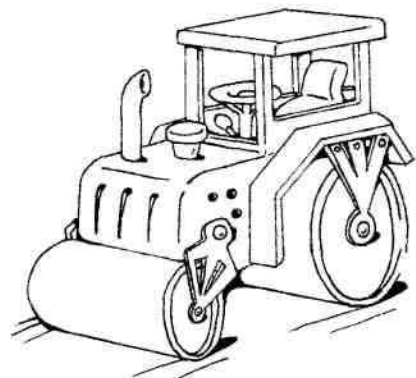



·Т·Р·А·Н·С·П·О·Р·Т·

·Д·О·Р·О·Г·А·

·Т·Е·Х·Н·И·К·А·

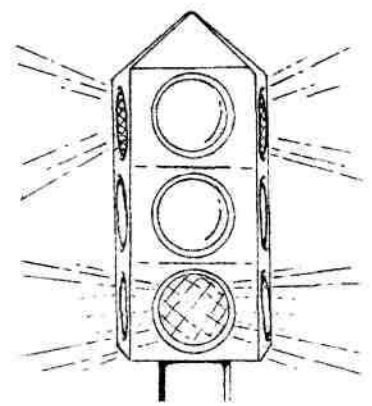
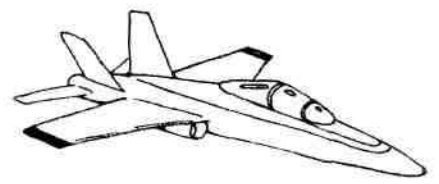
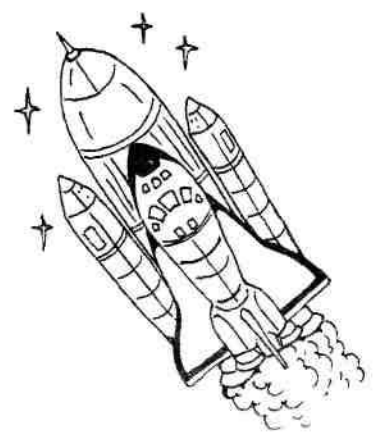
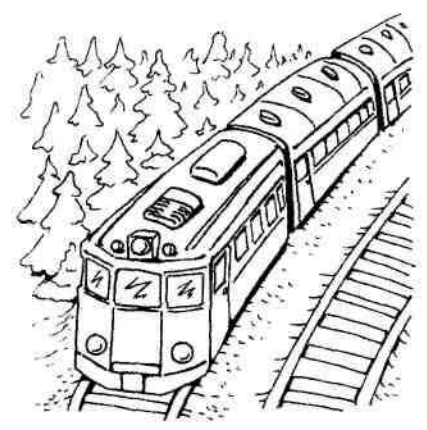
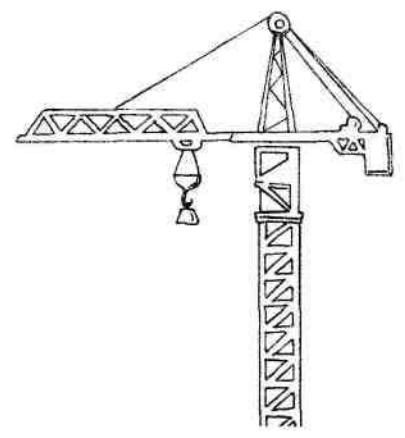
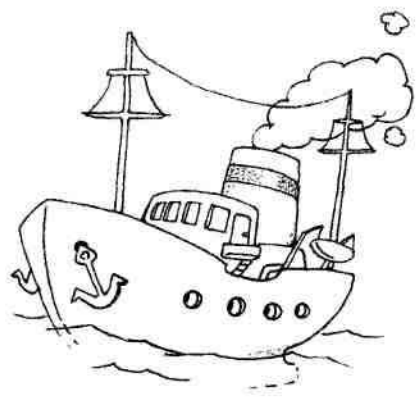

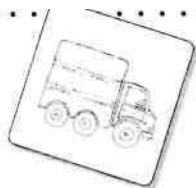

· Т · Р · А · Н · С · П · О · Р · Т ·

· Д · О · Р · О · Г · А ·

· Т · Е · Х · Н · И · К · А ·

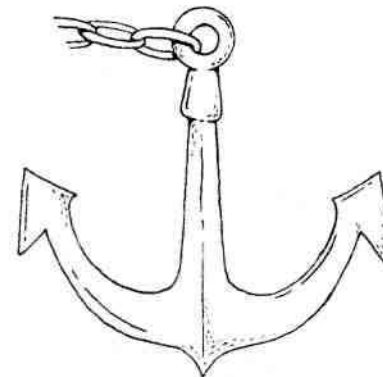
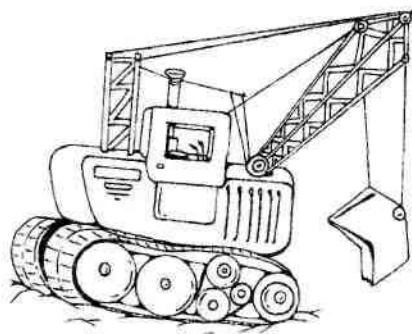
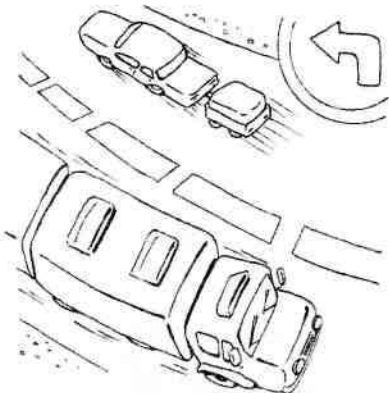
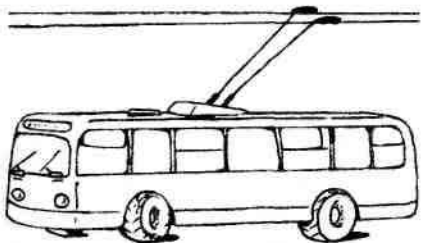
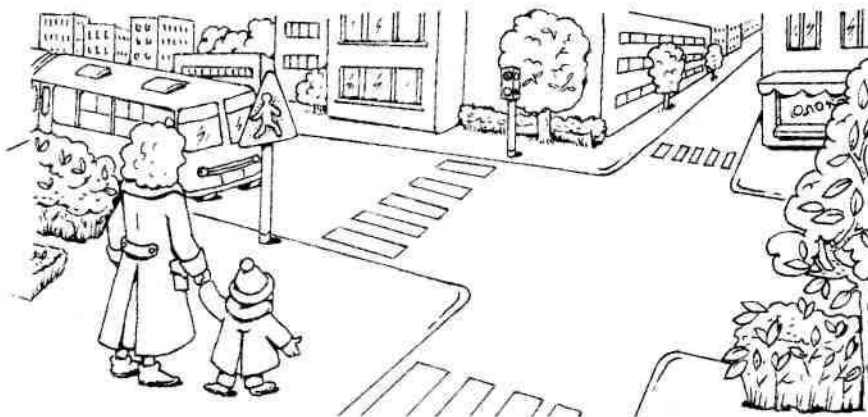
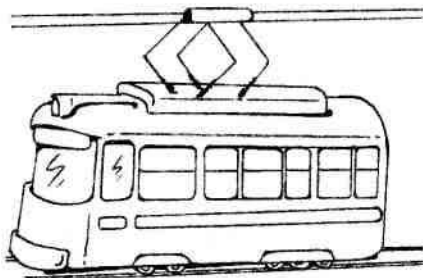
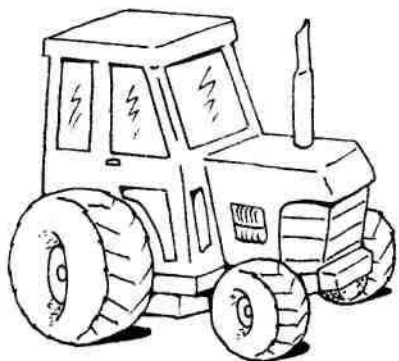



· В · · Д · Е · Р · Е · В · Н · Е ·

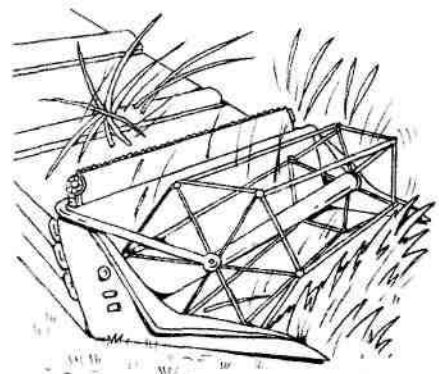
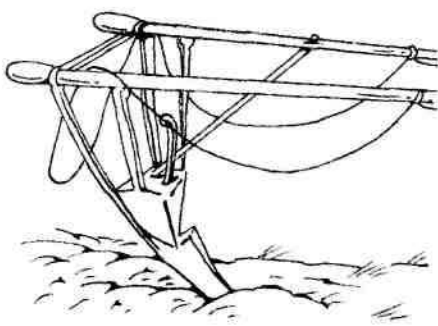
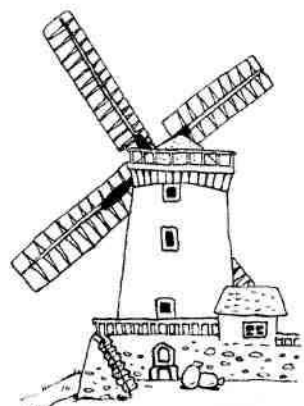
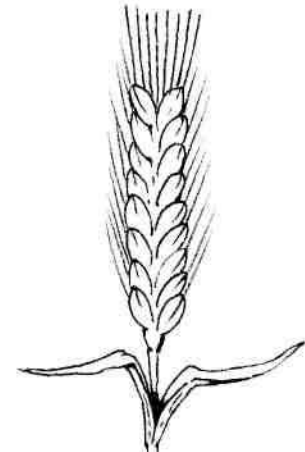
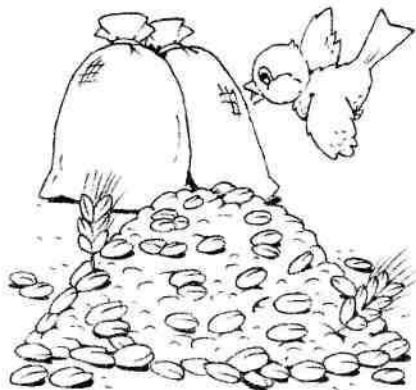
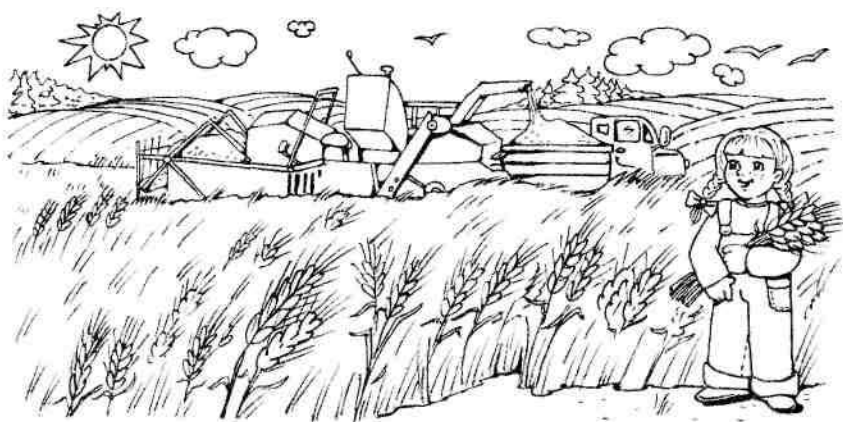



· Д · О · М · А · Ш · Н · И · Е · Ж · И · В · О · Т · Н · Ы · Е ·

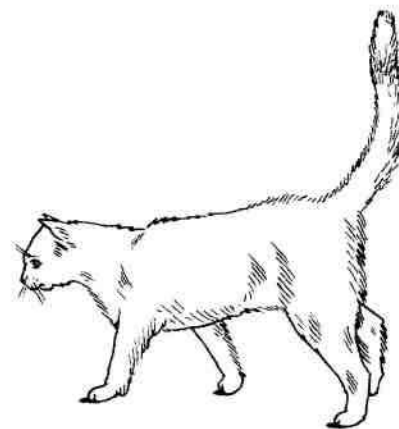
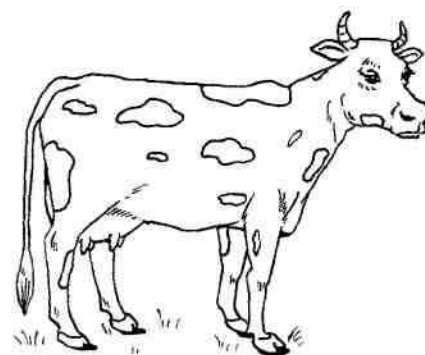
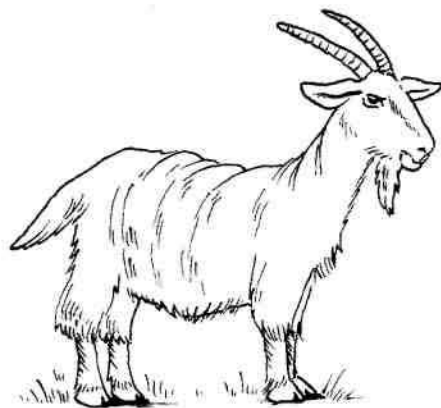
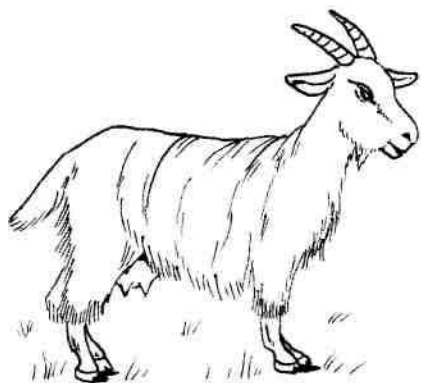
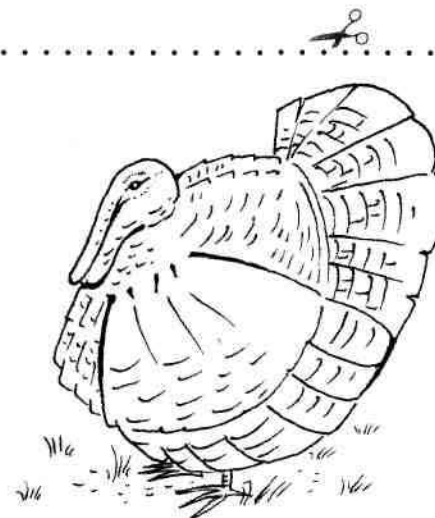
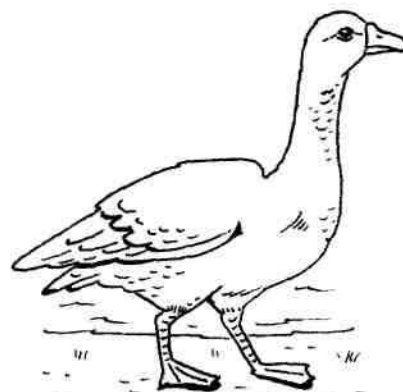
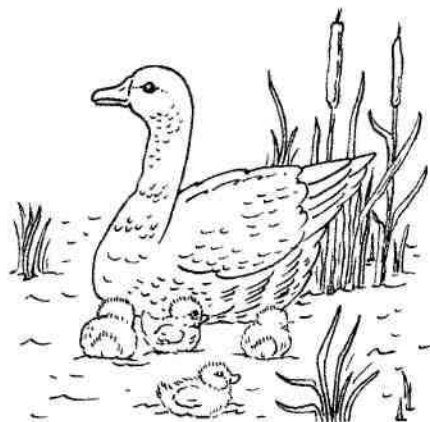
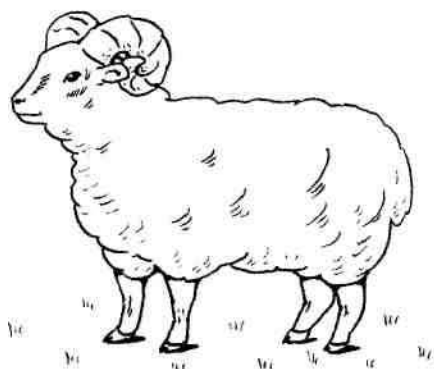



· Д · О · М · А · Ш · Н · И · Е · Ж · И · В · О · Т · Н · Ы · Е ·

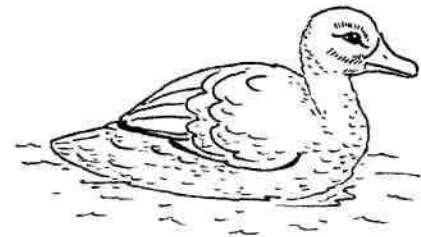
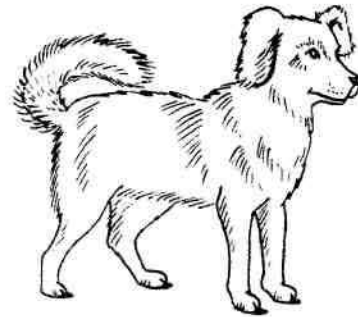
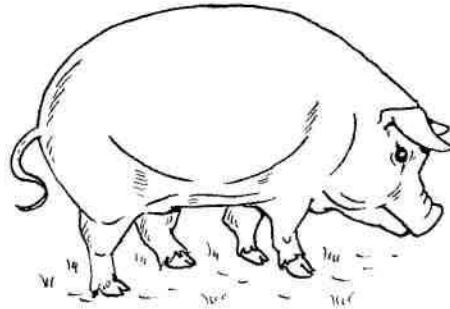
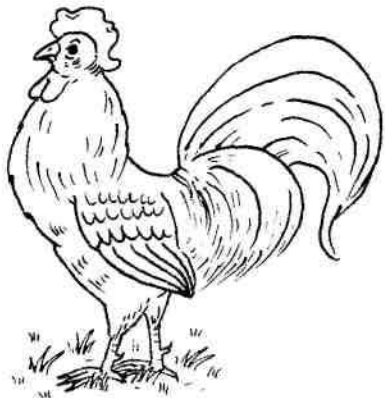
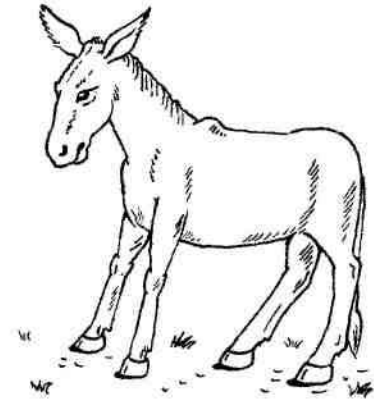
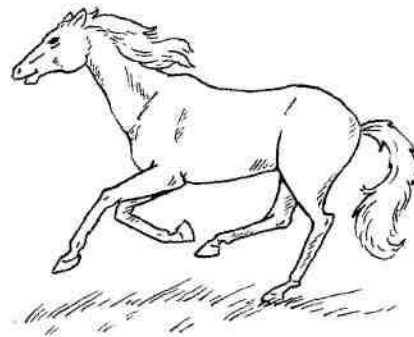
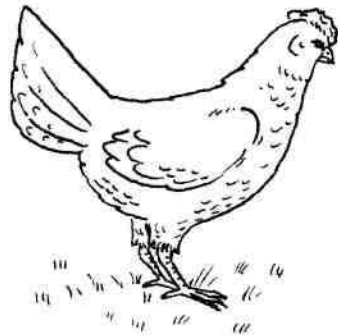
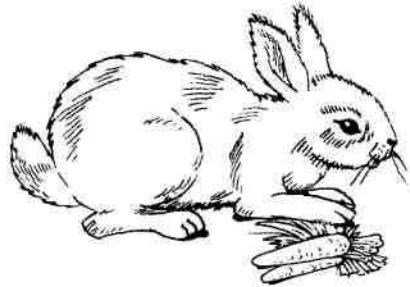



· Детеныши ·

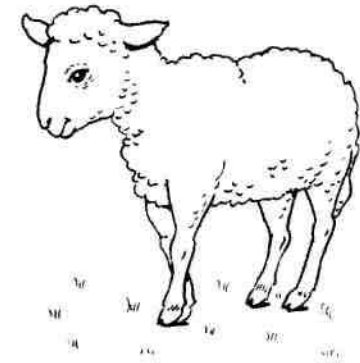
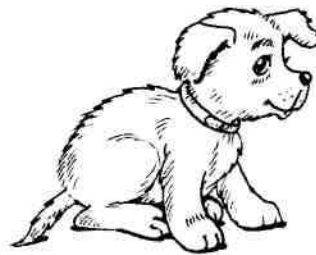
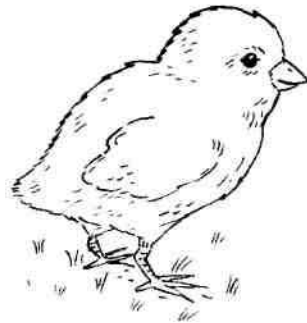
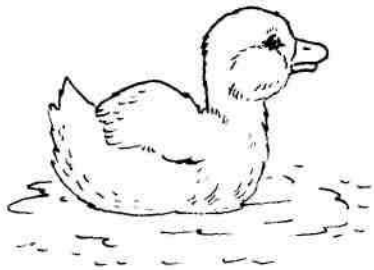
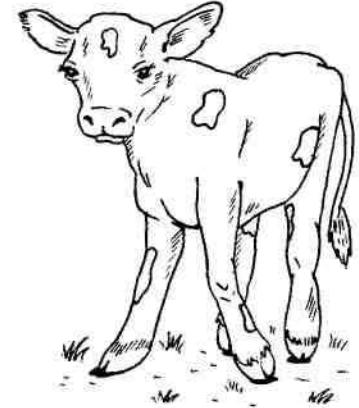
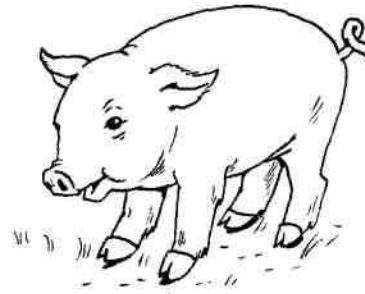
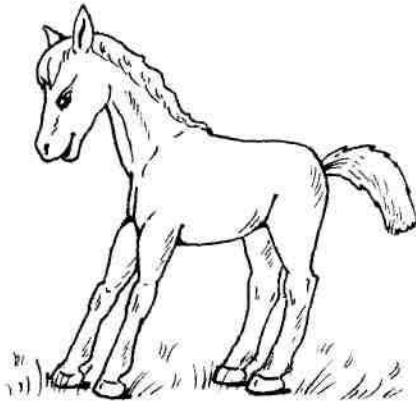

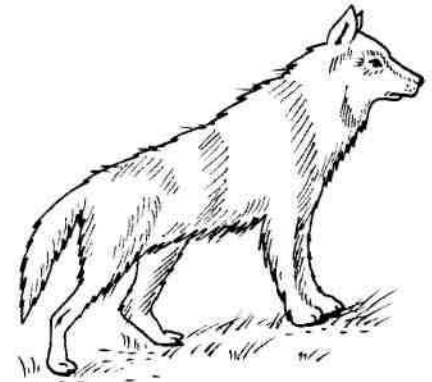
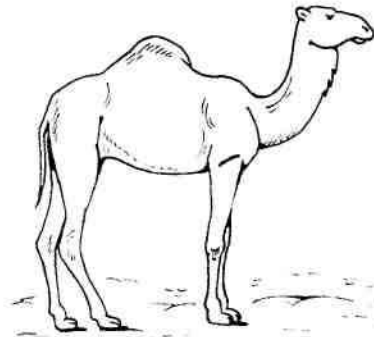
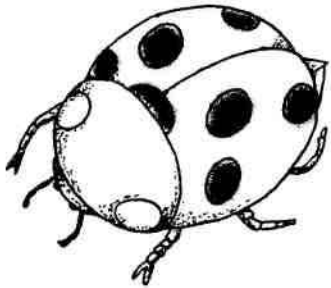
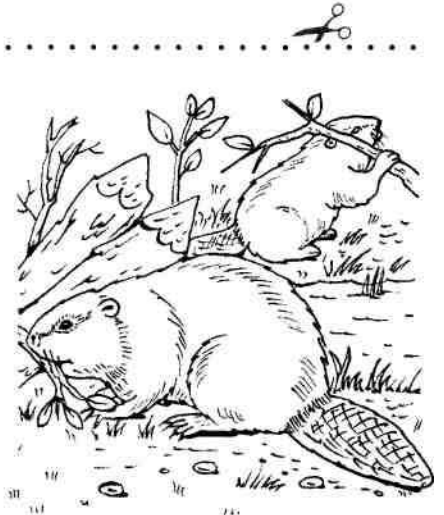
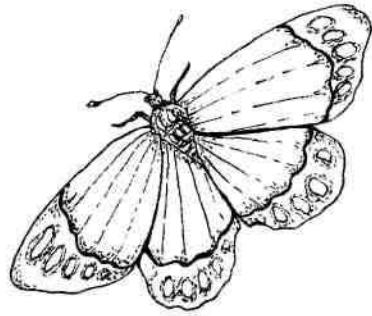
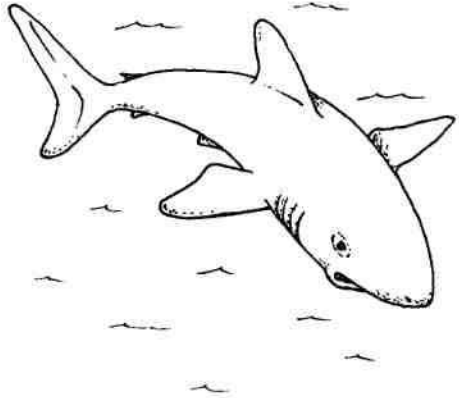

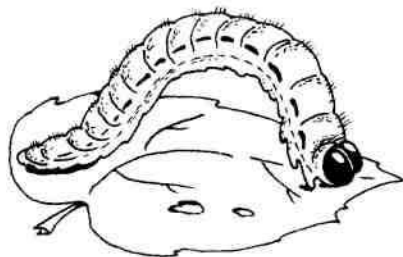
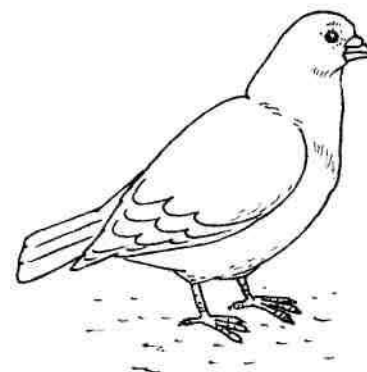
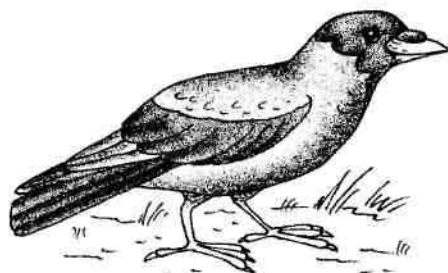
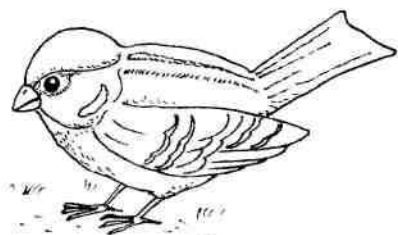



· Д · И · К · И · Е · Ж · И · В · О · Т · Н · Ы · Е ·

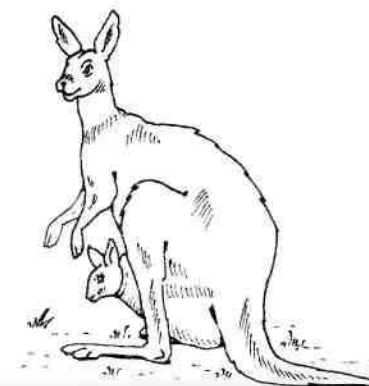
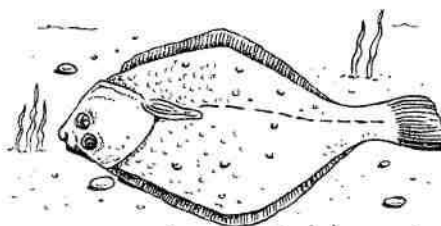
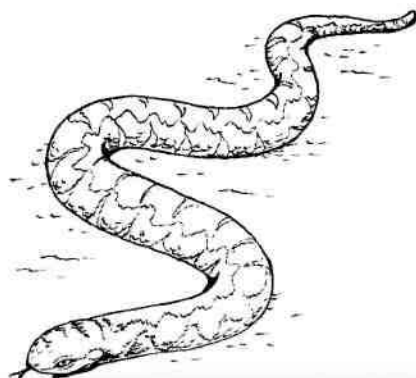
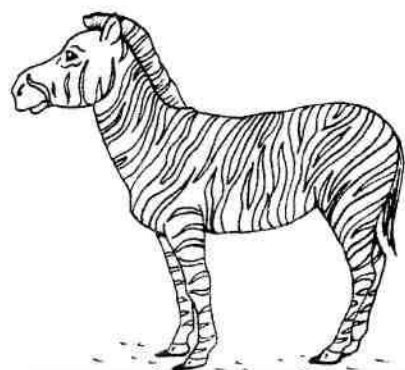
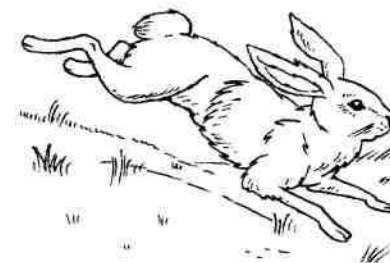
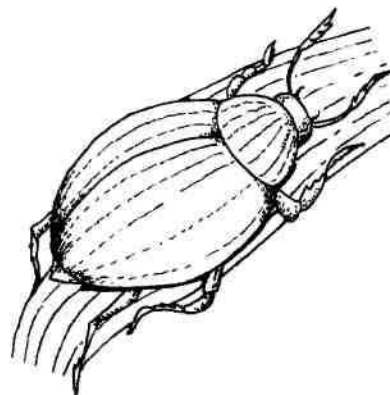
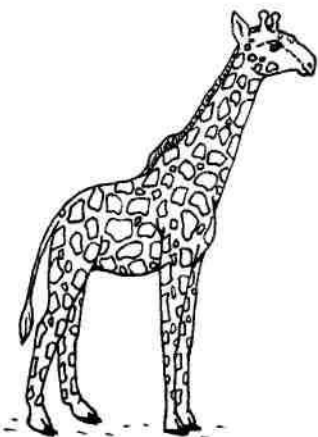
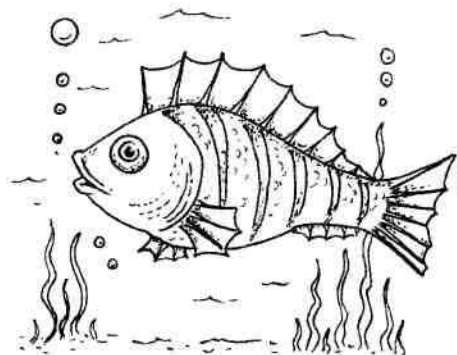



· Д · И · К · И · Е · Ж · И · В · О · Т · Н · Ы · Е ·

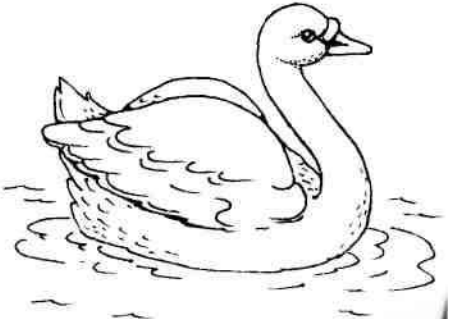
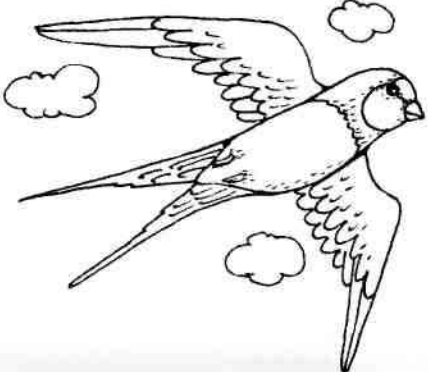
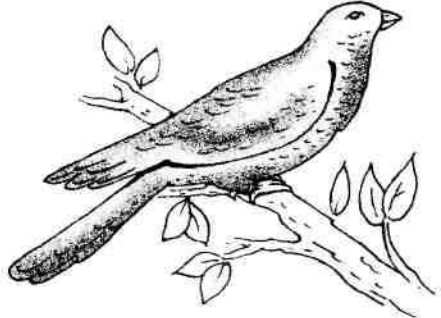
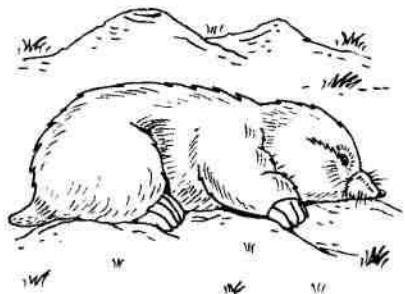
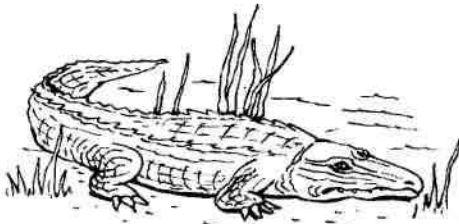
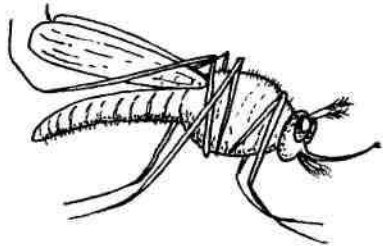
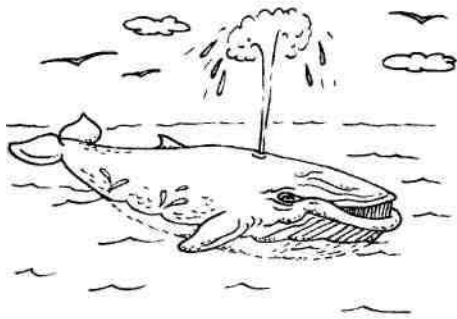



· Д · И · К · И · Е · Ж · И · В · О · Т · Н · Ы · Е ·

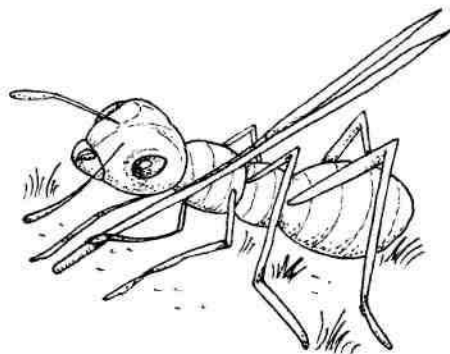
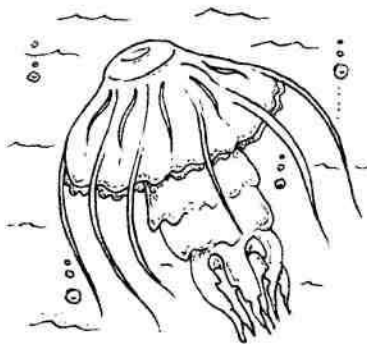
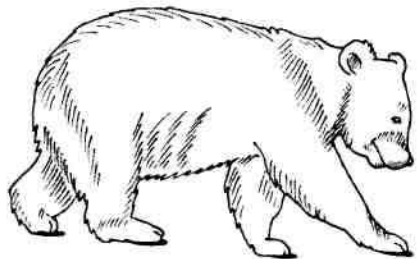
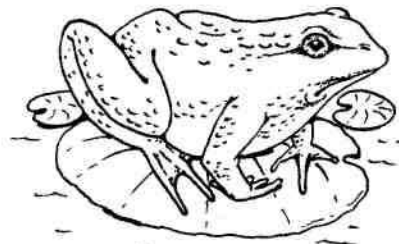
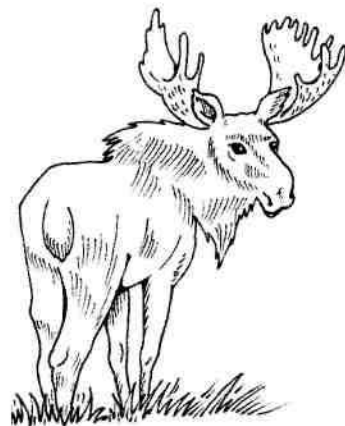
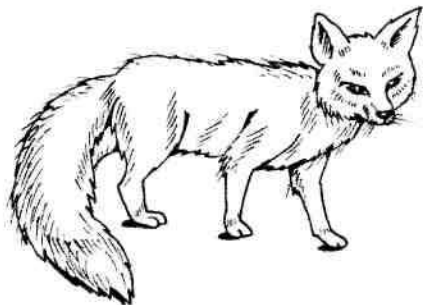
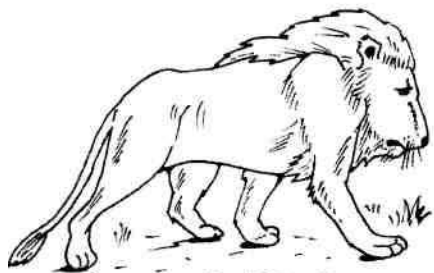



· Д · И · К · И · Е · Ж · И · В · О · Т · Н · Ы · Е ·

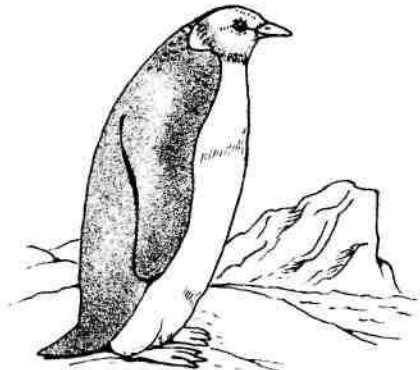
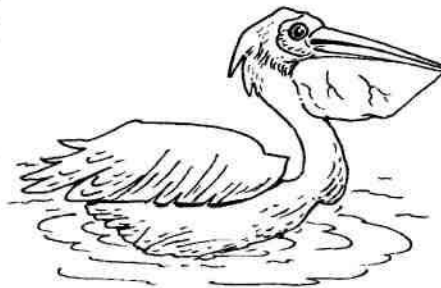
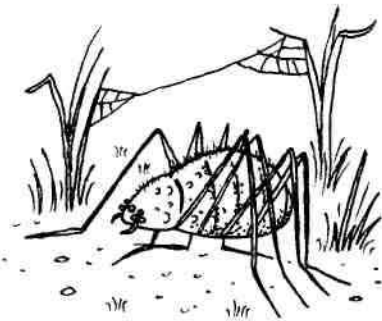
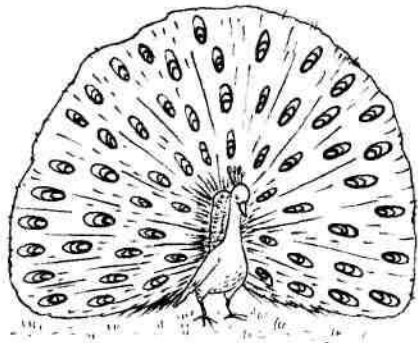
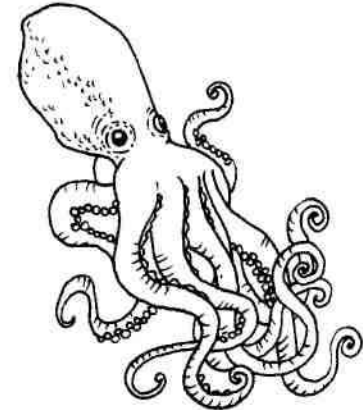
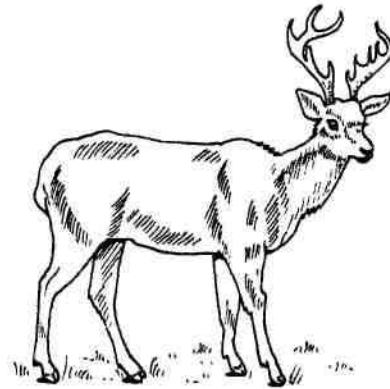
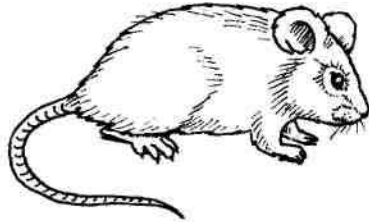
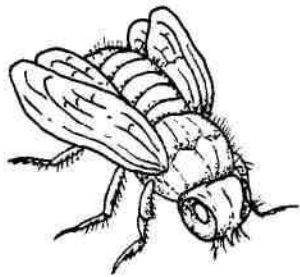



· Д · И · К · И · Е · Ж · И · В · О · Т · Н · Ы · Е ·

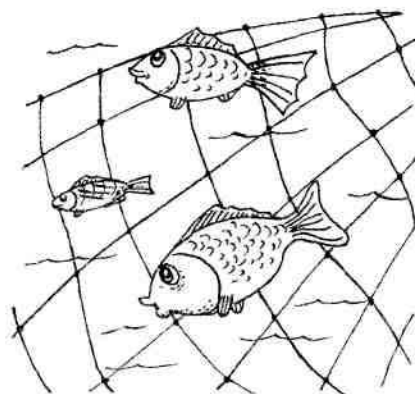
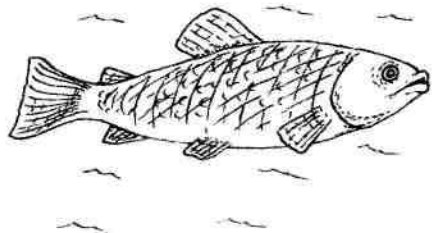
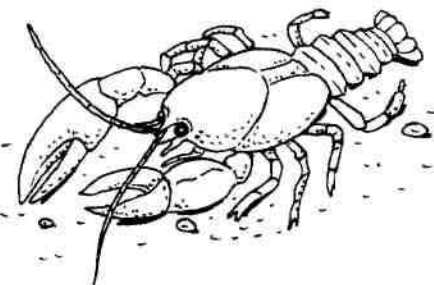
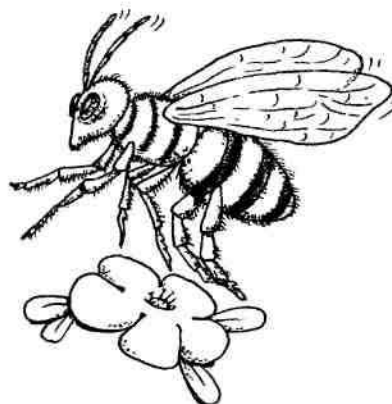



· Д · И · К · И · Е · Ж · И · В · О · Т · Н · Ы · Е ·

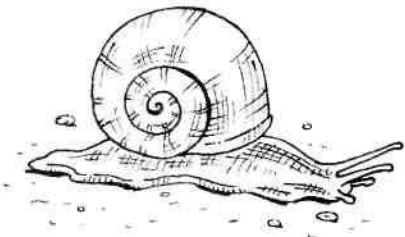
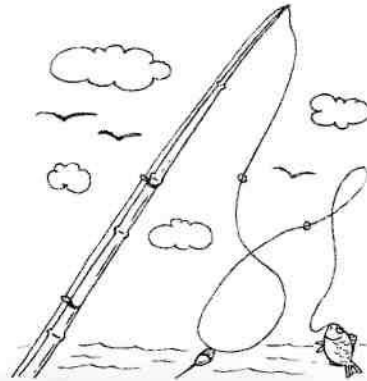
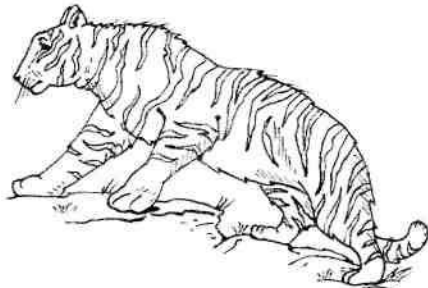
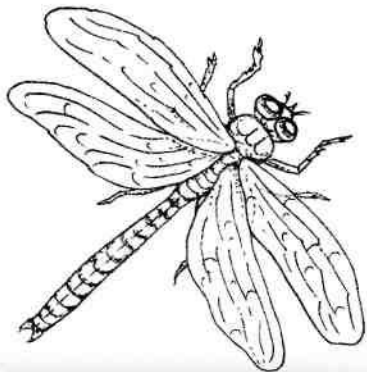
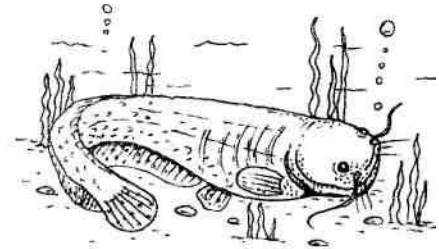
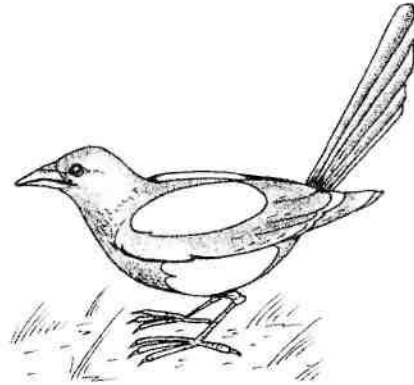
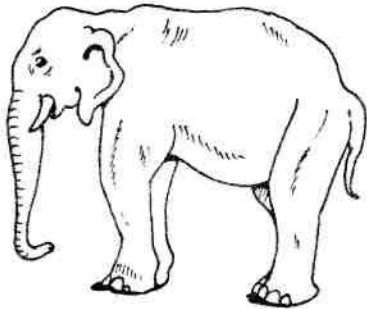



· Д · И · К · И · Е · Ж · И · В · О · Т · Н · Ы · Е ·

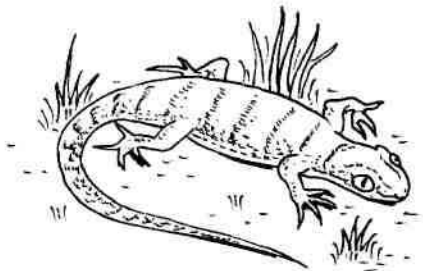
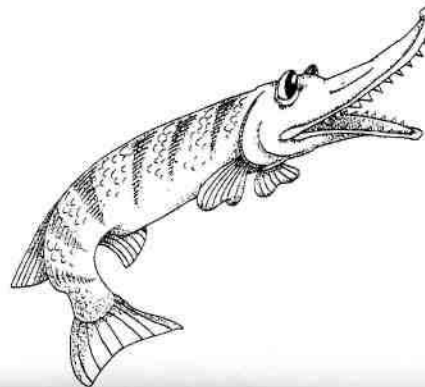
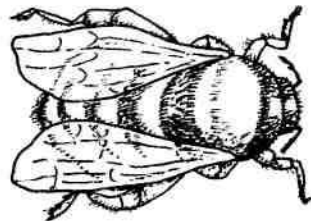
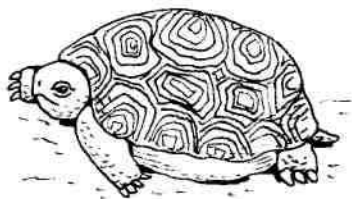
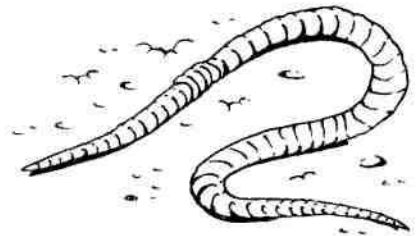
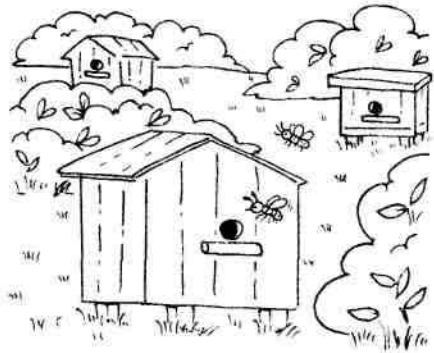

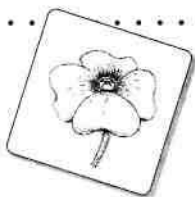

·Р·А·С·Т·Е·Н·И·Я·

· 89 ·

·деревья, цветы, грибы·

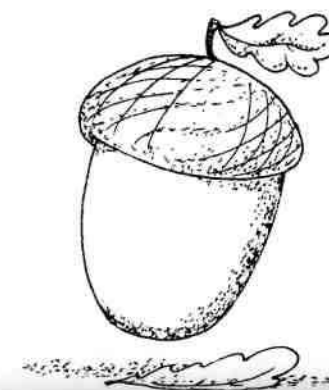
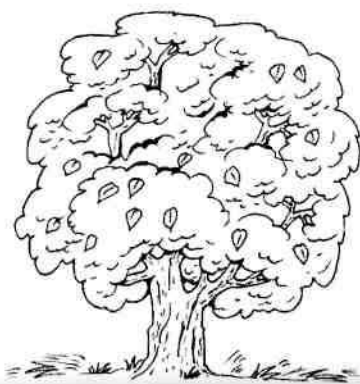
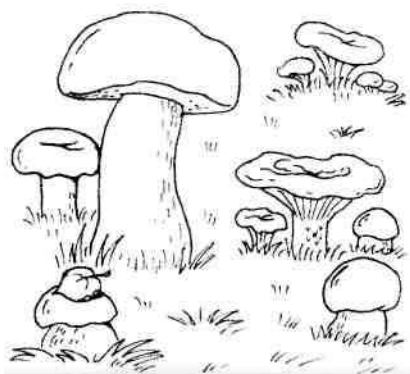

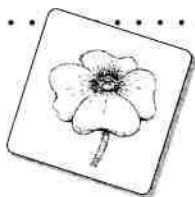

·Р·А·С·Т·Е·Н·И·Я·

· 91 ·

·деревья, цветы, грибы·

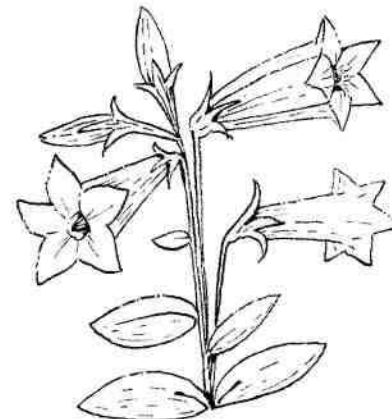
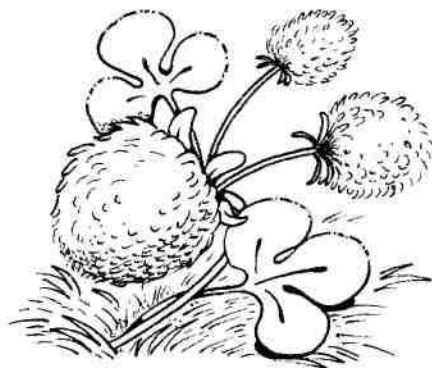
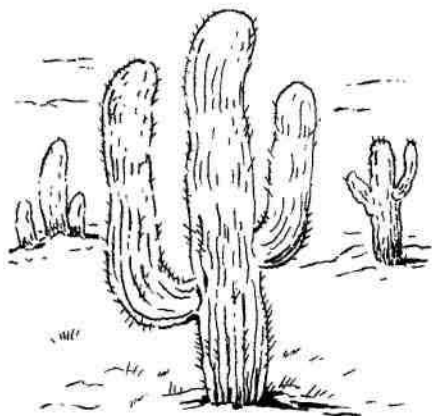
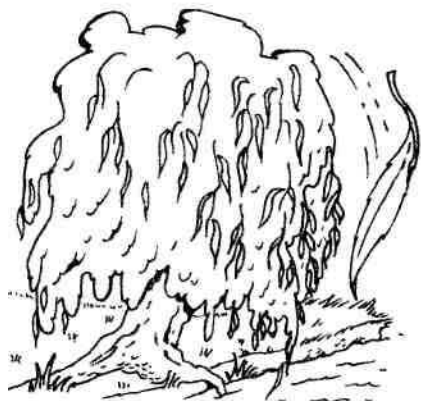

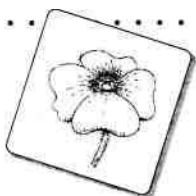

·Р·А·С·Т·Е·Н·И·Я·

· 93 ·

·деревья, цветы, грибы·

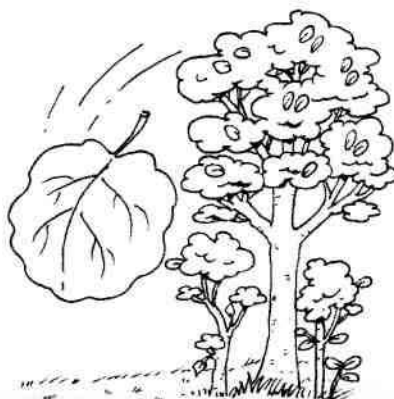
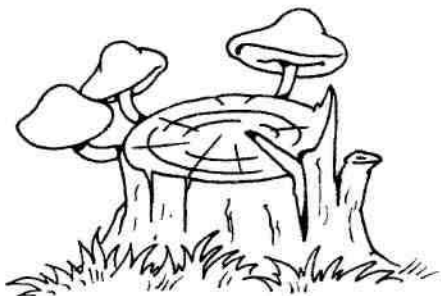
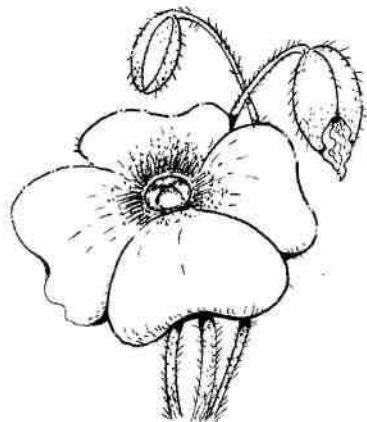
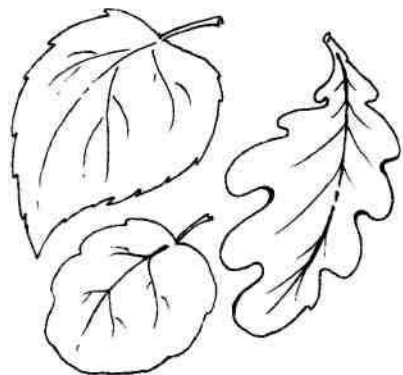

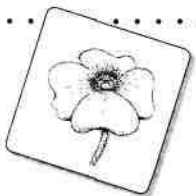

· Р · А · С · Т · Е · Н · И · Я ·

· деревья, цветы, грибы ·

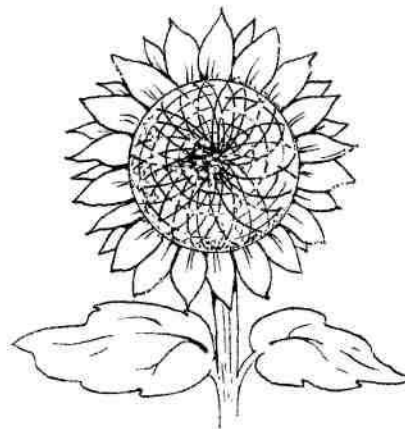
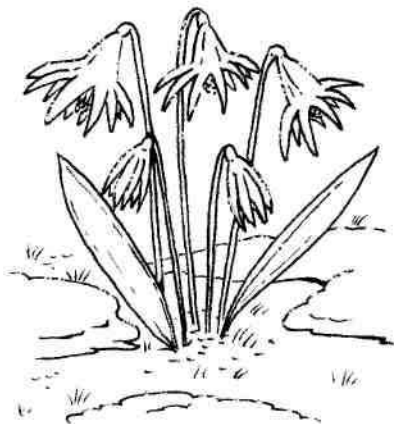



· П · Р · О · Ф · Е · С · С · И · И ·

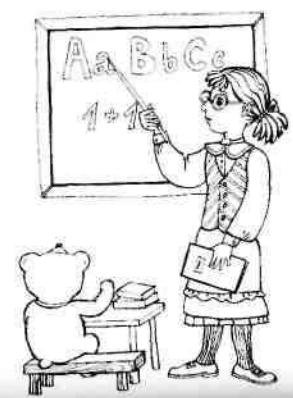

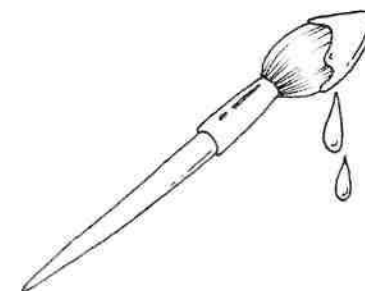
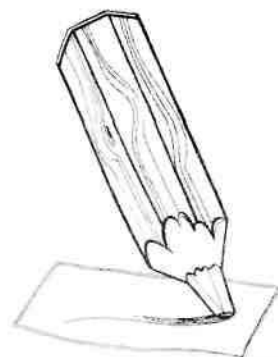

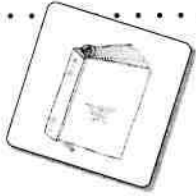

· Ш · К · О · Л · Я ·

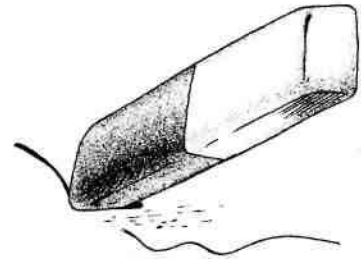
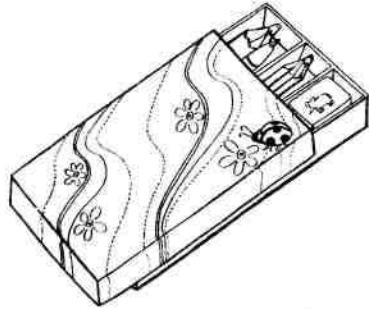
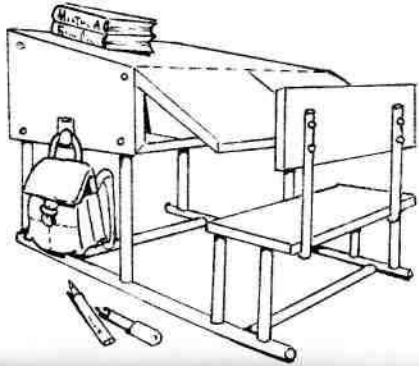
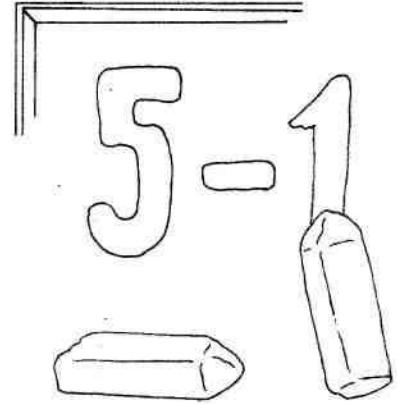
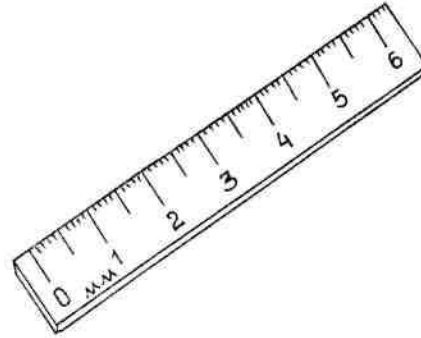
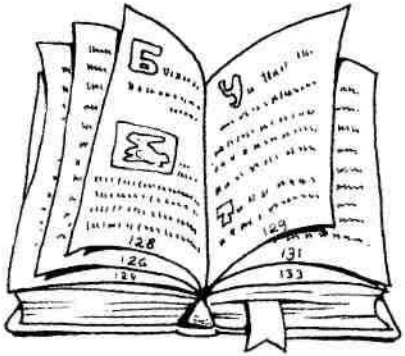

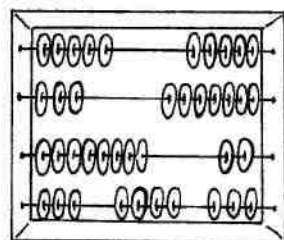
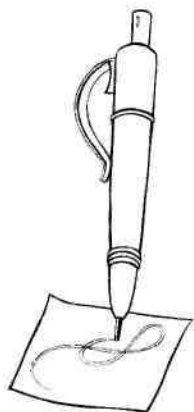

$$1 + 2 = 3$$

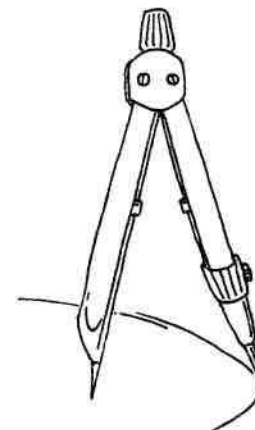

9 6 3
0 4 1
7 5 8

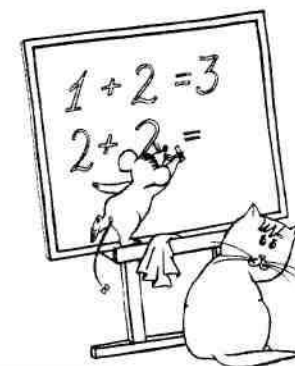
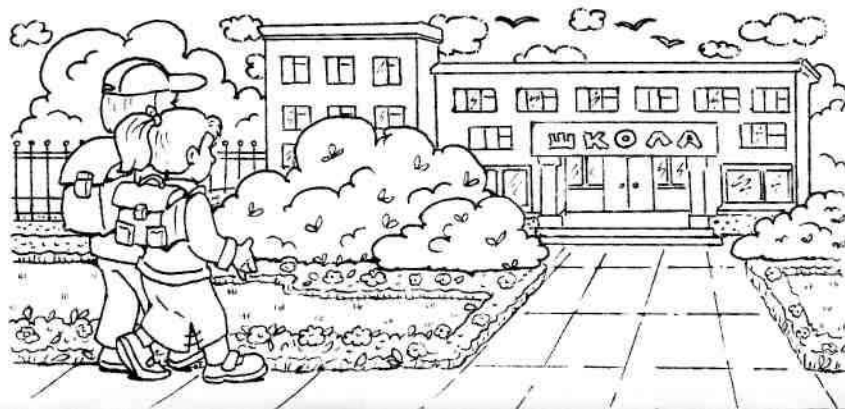



· С · П · О · Р · Т ·

· Д · О · С · У · Г ·

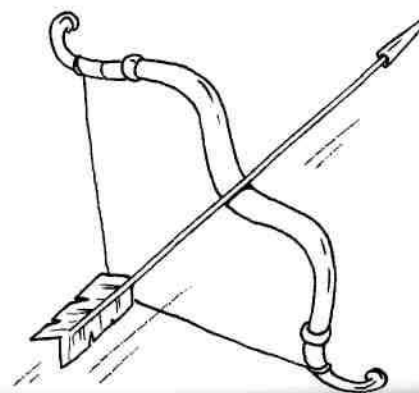
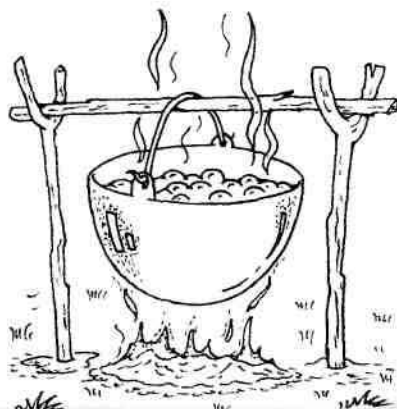
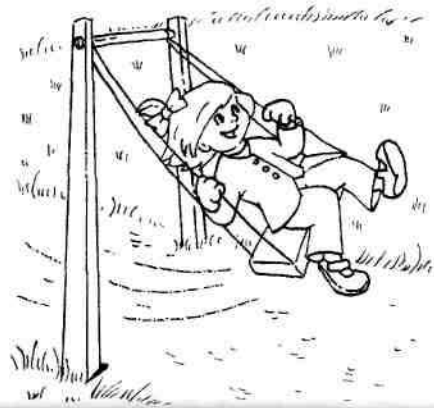
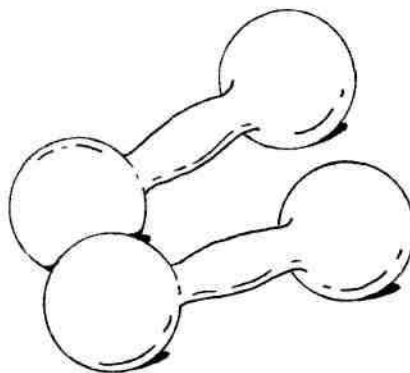
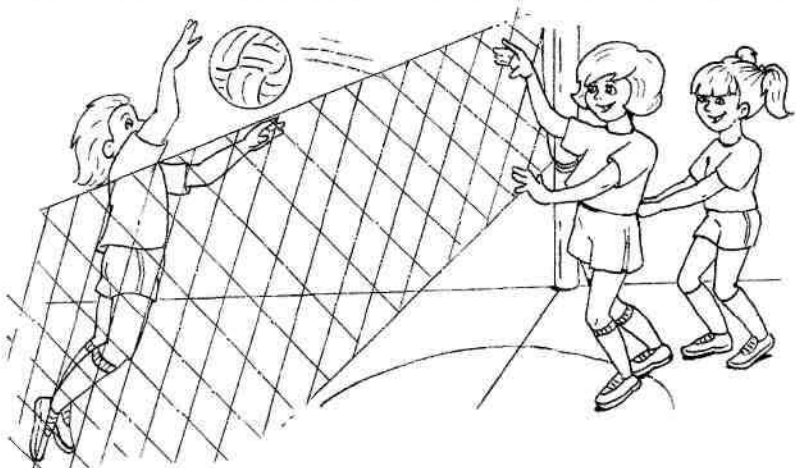

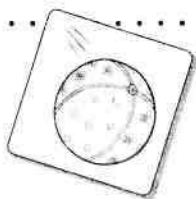

·С·П·О·Р·Т·

·Д·О·С·У·Г·

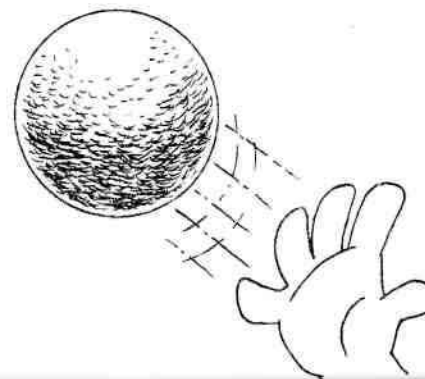
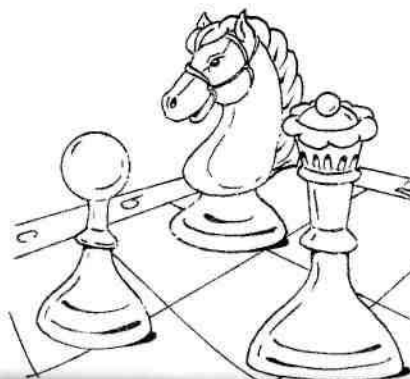
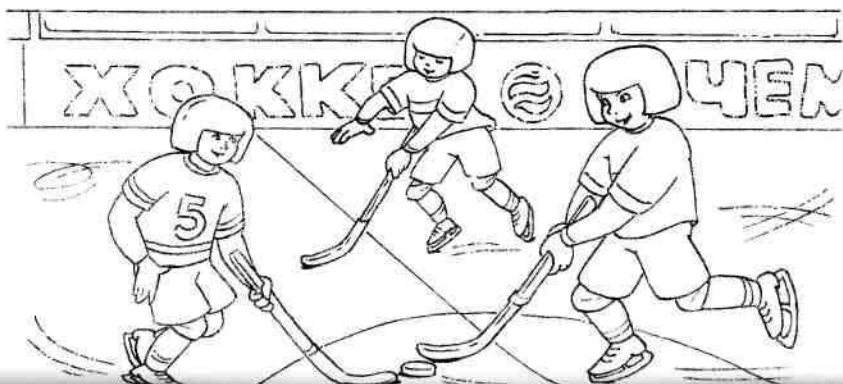
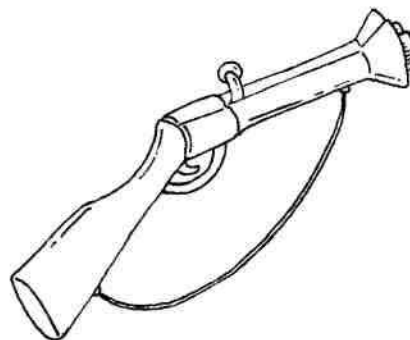

• Список слов •

ИГРУШКИ

Буратино, зайка, кубики, кукла, лошадка, матрешки, машина заводная, медвежонок, мяч, неваляшка, погремушка, скакалка, флажки, хлопушка, шарик воздушный, юла.

ОДЕЖДА. ОБУВЬ

Бант, ботинки, варежка и перчатка, панамка, сапоги, тапки, шапка, шуба.

ГИГИЕНА

Банный веник, ванна, душ, зубная щетка, мочалка, мыло, полотенце, расческа.

ОВОЩИ. ФРУКТЫ. ЯГОДЫ

Абрикос, арбуз, банан, виноград, вишня, горох, гранат, груша, дыня, земляника, кабачок, капуста, картофель, клубника, клюква, крыжовник, лимон, лук, малина, морковь, огурец, перец, помидор, редис, репа, свекла, слива, тыква, черника, чеснок, яблоко, ягода.

ПРОДУКТЫ

Баранки, бублик, булка, конфета, лапша, масло, мед, молоко, мороженое, орех, пирог, сахар, соль, тесто, хлеб, яйцо.

ДОМ. МЕБЕЛЬ. ПРЕДМЕТЫ

Аквариум, антенна, буфет, вешалка, водопровод, газета, газовая плита, дверь, диван, дом, дым, забор, замок, зеркало, зонт, ключ, ковер, кран, кровать, лестница, лифт, метла, окно, письмо, подушка, почтовый ящик, простыня, спичечный коробок, спички, стол, стул, труба.

БЫТОВЫЕ ПРИБОРЫ. ИНСТРУМЕНТЫ

Будильник, булавка, выключатель, гвоздь, грабли, игла, катушка, клубок, компас, компьютер, коса, лампочка, лейка, лопата, магнитофон, молоток, ножницы, пила, пылесос, робот, рубанок, спицы, телевизор, телефон, термометр, топор, утюг, фотоаппарат, холодильник, часы, шланг, щетка.

ПОСУДА

Бочка, бутылки, ведро, вилка, ложка, нож, посуда, сахарница, сито, сковорода, стакан, тарелка, термос, хлебница, чайник, чашка.

ВРЕМЯ

День, дни недели, календарь, месяцы, ночь, утро.

ВРЕМЕНА ГОДА-ЯВЛЕНИЯ ПРИРОДЫ

Весна, зима, лето, осень, ветер, горка ледяная, град, гроза, Дед Мороз, дождь, елка, звезды, иней, коньки, кормушка, лед, лужа, луна, лыжи, месяц, небо, облака, радуга, роса, санки, снеговик, снежинка, солнце, сосульки, тень, туча.

ТРАНСПОРТ. ДОРОГА. ТЕХНИКА

Автобус, автомобиль, бульдозер, вагоны, велосипед, вертолет, дорога, коток, колесо, корабль, лодка, метро, мост, мотоцикл,

паровоз, пароход, подъемный кран, поезд, поливальная машина, ракета, самолет, светофор, снегоуборочная машина, трактор, трамвай, троллейбус, улица, шоссе, экскаватор, якорь.

В ДЕРЕВНЕ

Жатва, зерно, колос, комбайн, мельница, плуг, сенокосилка.

ДОМАШНИЕ ЖИВОТНЫЕ

Баран, утка с утятами, гусь, индюк, коза, козел, корова, кошка (кот), кролик, курица, лошадь, осел, петух, свинья, собака, утка.

ДЕТЕНЫШИ

Жеребенок, котенок, поросенок, теленок, утенок, цыпленок, щенок, ягненок.

ДИКИЕ ЖИВОТНЫЕ

Акула, бабочка, белка, бобры, божья коровка, бурундук, верблюд, волк, воробей, ворона, гнездо, голубь, гусеница, дятел, еж, енот, ерш, жираф, жук, заяц, зебра, змея, камбала, кенгуру, кит, комар, крокодил, крот, кузнечик, кукушка, ласточка, лебедь, лев, лиса, лось, лягушка, медведь, медуза, муравей, муравейник, муха, мышь, олень, осьминог, павлин, паук, пеликан, пингвин, попугай, птенец, пчела, рак, рыба, рысь, сеть, скворец, слон, сова, сорока, сом, стрекоза, тигр, удочка, улитка, улья, хомяк, цапля, червяк дождевой, черепаха, шмель, щука, ящерица.

РАСТЕНИЯ (деревья, цветы, грибы)

Береза, боровик, василек, гвоздика, грибы, дерево, ель, желудь, ива, кактус, клевер, колокольчик, ландыш, лес, лилия, лисички, листья, мак, мимоза, мухомор, одуванчик, опята, осина, поганка, подберезовик, подснежник, подсолнух, репейник, роза, ромашка, рябина, шишка.

ПРОФЕССИИ

Артист, водитель, врач (доктор), маляр, повар, пожарный, сапожник, учитель.

ШКОЛА

Алфавит, букварь, буквы, глобус, дневник, карандаш, карта, кисточка, книга, краски, линейка, мел, парта, пенал, ранец, резинка (ластик), ручка, счеты, тетрадь, циркуль, цифры, школа, школьная доска.

СПОРТ, ДОСУГ

Волейбол, гантели, карусель, качели, костер, котелок, лук и стрела, палатка, парашют, ружье, рюкзак, хоккей, шахматы, ядро.

• СОДЕРЖАНИЕ •

ОТ АВТОРА	1
ИГРУШКИ.....	3
ОДЕЖДА. ОБУВЬ	7
ГИГИЕНА	9
ОВОЩИ. ФРУКТЫ. ЯГОДЫ	11
ПРОДУКТЫ	19
ДОМ. МЕБЕЛЬ. ПРЕДМЕТЫ	23
БЫТОВЫЕ ПРИБОРЫ. ИНСТРУМЕНТЫ	31
ПОСУДА	39
ВРЕМЯ	43
ВРЕМЕНА ГОДА. ЯВЛЕНИЯ ПРИРОДЫ	47
ТРАНСПОРТ. ДОРОГА. ТЕХНИКА	55
В ДЕРЕВНЕ	63
ДОМАШНИЕ ЖИВОТНЫЕ	65
ДИКИЕ ЖИВОТНЫЕ	73
РАСТЕНИЯ (деревья, цветы, грибы)	91
ПРОФЕССИИ	97
ШКОЛА	99
СПОРТ. ДОСУГ	105
СПИСОК СЛОВ	109